

Suggested Trade
Price Schedule
Effective March 29, 1993

Superstrut[®]

Metal Framing, Channel, Fittings,
Pipe Straps, and Beam Clamps

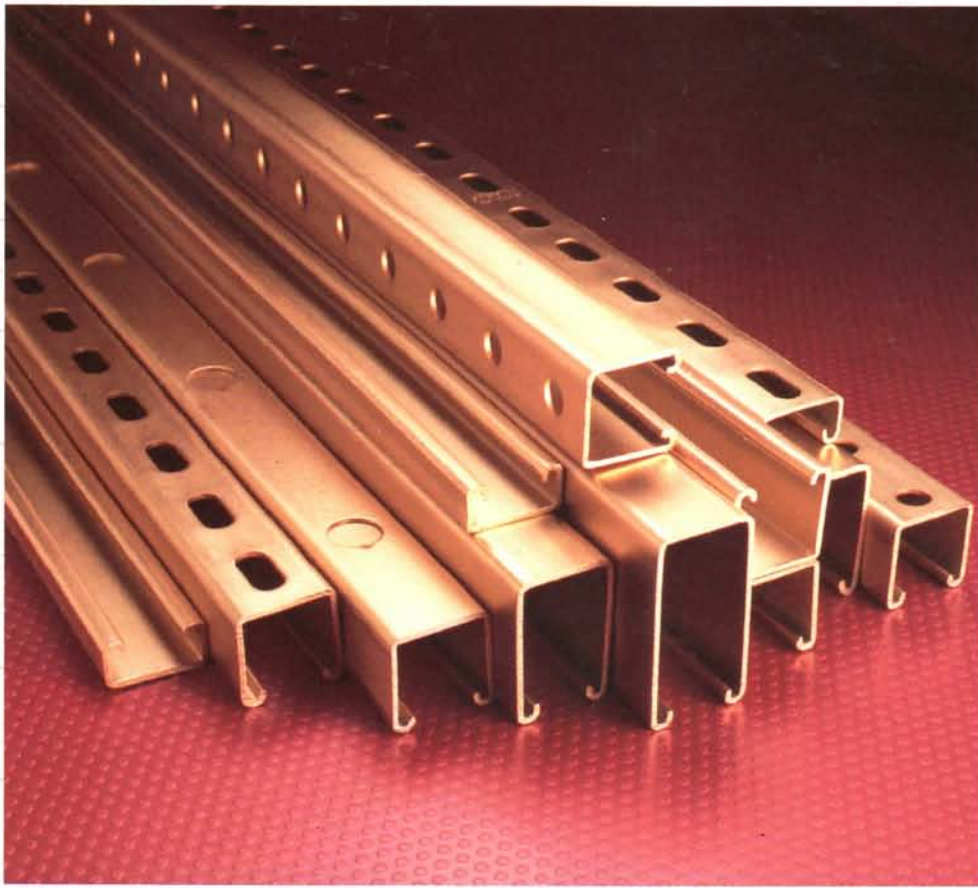

Thomas & Betts

NOTES

Lined area for taking notes, consisting of approximately 15 horizontal lines.

Thomas & Betts

Thomas & Betts
Electrical Components Group
1555 Lynnfield Road
Memphis, Tennessee 38119
(901) 682-8221 ext. 8324 (Technical Services)

CONTENTS

HOW TO ORDER

1. Show quantity.
2. Select catalog number.
3. Show size or length.
4. Specify finish—if other than EC (Goldguard)
 EC—is Goldguard—not necessary to specify.
 PG—Pre-galvanized
 GR—Green
 HDG—Hot-dipped galvanized
 B—Black steel
 Note: Refer to Page 39 for detailed finish information.
5. WHEN OTHER MATERIALS ARE DESIRED, specify as follows:
 AL—Aluminum
 SS—Stainless Steel
 PVC—Polyvinylchloride coating
6. Show complete shipping instructions.

SERIES	DESCRIPTION	PAGE(S)
	Alphanumeric Price Sheet and Index	4-13
1000	Channel	14-16
100	Channel Nuts.....	17-19
100	Threaded Rod	17-19
100	Hardware.....	17-19
200	Brackets/Fittings	20-25
300	Concrete Inserts.....	26
400	Concrete Inserts.....	26
500	Beam Clamps.....	27-29
700	Pipe Straps	30-32
700	Cush-A-Clamp	31
800	Electrical Raceway	33-35
RA	Superangle.....	36
	Special Metals	37-38

DISCOUNT SCHEDULE

SCHEDULE	DESCRIPTION	DISCOUNT
A	Channel	
B	Hardware—Fittings Concrete Inserts Beam Clamps	
C	Pipe Straps (700-701-702-703)	
F	Cush-a-Clamp	
S	Superangle	

Alphanumeric Price Sheet and Index

Catalog Number	Trade Price Per 100 Items or 100 Feet*		Std. Pkg. Qty.	Wt. Per 100 Pcs.	Page No.
	Standard Package				
Schedule A					
A-1200-10	\$ 294.75 *		500	190	14
A-1200-20	294.75 *		500	190	14
A-1200-AL	565.70 *		500	71	37
A-1200-10-HDG	456.45 *		500	190	14
A-1200-20-HDG	456.45 *		500	190	14
A-1200-10-PG	297.40 *		500	190	14
A-1200-20-PG	297.40 *		500	190	14
A-1200-SS	†		500	190	37
A-1200-10-GR	297.40 *		500	190	14
A-1200-20-GR	297.40 *		500	190	14
A-1200-HS-10	316.35 *		500	185	14
A-1200-HS-10-GR	320.40 *		500	185	14
A-1200-HS-20	316.35 *		500	185	14
A-1200-HS-20-GR	320.40 *		500	185	14
A-1200-HS-AL	684.45 *		500	70	37
A-1200-HS-10-HDG	508.50 *		500	185	14
A-1200-HS-20-HDG	508.50 *		500	185	14
A-1200-HS-10-PG	320.40 *		500	185	14
A-1200-HS-20-PG	320.40 *		500	185	14
A-1200-HS-SS	†		500	185	37
A-1200-KO-10**	334.35 *		500	190	14
A-1200-KO-20	334.35 *		500	190	14
A-1200-P-10	324.50 *		500	185	14
A-1200-P-20	324.50 *		500	185	14
A-1200-P-10-GR	328.30 *		500	185	14
A-1200-P-20-GR	328.30 *		500	185	14
A-1200-P-10-HDG	508.50 *		500	185	14
A-1200-P-20-HDG	508.50 *		500	185	14
A-1200-P-10-PG	328.30 *		500	185	14
A-1200-P-20-PG	328.30 *		500	185	14
A-1200-S-10	331.35 *		500	180	14
A-1200-S-20	331.35 *		500	180	14
A-1200-S-10-GR	341.35 *		500	180	14
A-1200-S-20-GR	341.35 *		500	180	14
A-1200-S-10-PG	341.35 *		500	180	14
A-1200-S-20-PG	341.35 *		500	180	14
A-1202-10	630.10 *		250	380	14
A-1202-20	630.10 *		250	380	14
A-1202-10-AL	†		250	135	37
A-1202-20-AL	†		250	135	37
A-1202-10-GR	642.70		250	380	14
A-1202-20-GR	642.70		250	380	14
A-1202-10-HDG	1000.10 *		250	380	14
A-1202-20-HDG	1000.10 *		250	380	14
A-1202-10-PG	712.30 *		250	380	14
A-1202-20-PG	712.30 *		250	380	14
A-1202-HS-10	852.30 *		250	370	14
A-1202-HS-20	852.30 *		250	370	14
A-1202-HS-10-HDG	1271.35 *		250	380	14
A-1202-HS-20-HDG	1271.35 *		250	380	14
A-1202-HS-10-PG	931.50 *		250	380	14
A-1202-HS-20-PG	931.50 *		250	380	14
A-1203-A	†		bulk	570	14
A-1203-B	†		bulk	570	14
A-1203-C	†		bulk	570	14

Catalog Number	Trade Price Per 100 Items or 100 Feet*		Std. Pkg. Qty.	Wt. Per 100 Pcs.	Page No.
	Standard Package				
A-1203-D	†		bulk	570	14
A-1204	†		bulk	760	14
A-1400-10	\$ 253.50 *		500	140	16
A-1400-20	253.50 *		500	140	16
A-1400-10-GR	254.90 *		500	140	16
A-1400-20-GR	254.90 *		500	140	16
A-1400-10-HDG	393.55 *		500	140	16
A-1400-20-HDG	393.55 *		500	140	16
A-1400-10-PG	254.90 *		500	140	16
A-1400-20-PG	254.90 *		500	140	16
A-1400-HS-10	281.00 *		500	136	16
A-1400-HS-20	281.00 *		500	136	16
A-1400-HS-10-GR	283.85 *		500	136	16
A-1400-HS-20-GR	283.85 *		500	136	16
A-1400-HS-10-HDG	436.05 *		500	136	16
A-1400-HS-20-HDG	436.05 *		500	136	16
A-1400-HS-10-PG	283.85 *		500	136	16
A-1400-P-10	283.85 *		500	136	16
A-1400-KO-10	319.75 *		500	140	16
A-1400-KO-20	319.75 *		500	140	16
A-1400-KO-10-PG	321.10 *		500	140	16
A-1400-KO-20-PG	321.10 *		500	140	16
A-1400-P-10	313.90 *		500	136	16
A-1400-P-20	313.90 *		500	136	16
A-1400-P-10-HDG	471.15 *		500	136	16
A-1400-P-20-HDG	471.15 *		500	136	16
A-1400-P-10-PG	315.35 *		500	136	16
A-1400-P-20-PG	315.35 *		500	136	16
A-1400-S-10	300.40 *		500	137	16
A-1400-S-20	300.40 *		500	137	16
A-1400-S-10-HDG	466.50 *		500	137	16
A-1400-S-20-HDG	466.50 *		500	137	16
A-1400-S-10-PG	321.10 *		500	137	16
A-1400-S-20-PG	321.10 *		500	137	16
A-1402-10	620.55 *		250	280	16
A-1402-20	620.55 *		250	280	16
A-1402-10-HDG	899.30 *		250	280	16
A-1402-20-HDG	899.30 *		250	280	16
A-1402-10-PG	639.75 *		250	280	16
A-1402-20-PG	639.75 *		250	280	16
A-1402-A	†		250	280	16
A-1402-B	†				16
A-1402-C	†				16
B-1200-10	242.10 *		500	128	15
B-1200-20	242.10 *		500	128	15
B-1200-AL	404.10 *		500	52	37
B-1200-10-GR	264.05 *		500	128	15
B-1200-20-GR	264.05 *		500	128	15
B-1200-10-HDG	383.55 *		500	128	15
B-1200-20-HDG	383.55 *		500	128	15
B-1200-10-PG	264.05 *		500	128	15
B-1200-10-PG	264.05 *		500	128	15
B-1200-HS-10	267.85 *		500	123	15
B-1200-HS-20	267.85 *		500	123	15
B-1200-HS-10-GR	291.90 *		500	123	15

Prices subject to change without notice.
 †Contact Factory
 ***Prices standard packages are per pair.

Alphanumeric Price Sheet and Index (continued)

Catalog Number	Trade Price Per 100 Items or 100 Feet*		Std. Pkg. Qty.	Wt. Per 100 Pcs.	Page No.	Catalog Number	Trade Price Per 100 Items or 100 Feet*		Std. Pkg. Qty.	Wt. Per 100 Pcs.	Page No.
	Standard Package						Standard Package				
Schedule A (continued)											
B-1200-HS-20-GR	\$ 291.90 *		500	123	15	B-1400-S-10-HDG	\$ 371.70 *		500	85	16
B-1200-HS-10-HDG	415.90 *		500	123	15	B-1400-S-20-HDG	371.70 *		500	85	16
B-1200-HS-20-HDG	415.90 *		500	123	15	B-1400-S-10-PG	270.70 *		500	85	16
B-1200-HS-10-PG	291.90 *		500	123	15	B-1400-S-20-PG	270.70 *		500	85	16
B-1200-HS-20-PG	291.90 *		500	123	15	B-1402-10	508.55 *		250	194	16
B-1200-P-10	275.85 *		500	123	15	B-1402-20	508.55 *		250	194	16
B-1200-P-20	275.85 *		500	123	15	B-1402-10-HDG	737.05 *		250	194	16
B-1200-P-10-HDG	435.65 *		500	123	15	B-1402-20-HDG	737.05 *		250	194	16
B-1200-P-20-HDG	435.65 *		500	123	15	B-1402-10-PG	513.20 *		250	194	16
B-1200-P-10-PG	300.60 *		500	123	15	B-1402-20-PG	513.20 *		250	194	16
B-1200-P-20-PG	300.60 *		500	123	15	C-1200-10	305.15 *		500	170	15
B-1200-S-10	281.25 *		500	118	15	C-1200-20	305.15 *		500	170	15
B-1200-S-20	281.25 *		500	118	15	C-1200-10-HDG	458.15 *		500	170	15
B-1200-S-10-HDG	436.70 *		500	118	15	C-1200-20-HDG	458.15 *		500	170	15
B-1200-S-20-HDG	436.70 *		500	118	15	C-1200-10-PG	325.90 *		500	170	15
B-1200-S-10-PG	307.95 *		500	118	15	C-1200-20-PG	325.90 *		500	170	15
B-1200-S-20-PG	307.95 *		500	118	15	C-1200-HS-10	334.50 *		500	165	15
B-1202-10	528.00 *		250	256	15	C-1200-HS-20	334.50 *		500	165	15
B-1202-20	528.00 *		250	256	15	C-1200-HS-10-HDG	502.15 *		500	165	15
B-1202-AL	†*		500	93	37	C-1200-HS-20-HDG	502.15 *		500	165	15
B-1202-10-HDG	792.70 *		250	256	15	C-1200-HS-10-PG	357.15 *		500	165	15
B-1202-20-HDG	792.50 *		250	256	15	C-1200-HS-20-PG	357.15 †*		500	165	15
B-1202-10-PG	533.80 *		250	256	15	C-1202-10	706.05 *		250	340	15
B-1202-20-PG	533.80 *		250	256	15	C-1202-20	706.05 *		250	340	15
B-1400-10	194.75 *		500	97	16	C-1202-10-HDG	1023.30 †*		250	340	15
B-1400-20	194.75 *		500	97	16	C-1202-20-HDG	1023.30 †*		250	340	15
B-1400-10-GR	199.35 *		500	97	16	C-1202-10-PG	727.85 †*		250	340	15
B-1400-20-GR	199.35 *		500	97	16	C-1202-20-PG	727.85 †*		250	340	15
B-1400-10-HDG	326.50 *		500	97	16	E-1200-10	463.55 *		500	247	15
B-1400-20-HDG	326.50 *		500	97	16	E-1200-20	463.55 *		500	247	15
B-1400-10-PG	199.35 *		500	97	16	E-1200-10-HDG	695.80 †*		500	247	15
B-1400-20-PG	199.35 *		500	97	16	E-1200-20-HDG	695.80 †*		500	247	15
B-1400-SS	†		500	97	37	E-1200-10-PG	475.25 *		500	247	15
B-1400-HS-10	220.50 *		500	87	16	E-1200-20-PG	475.25 *		500	247	15
B-1400-HS-20	220.50 *		500	87	16	E-1200-HS-10	486.90 *		500	242	15
B-1400-HS-10-GR	225.15 *		500	87	16	E-1200-HS-20	516.35 *		500	242	15
B-1400-HS-20-GR	225.15 *		500	87	16	E-1200-HS-10-HDG	730.90 †*		500	242	15
B-1400-HS-10-HDG	342.40 *		500	87	16	E-1200-HS-20-HDG	730.90 †*		500	242	15
B-1400-HS-20-HDG	342.40 *		500	87	16	E-1200-HS-10-PG	539.75 *		500	242	15
B-1400-HS-10-PG	225.15 *		500	87	16	E-1200-HS-20-PG	539.75 *		500	242	15
B-1400-HS-20-PG	225.15 *		500	87	16	E-1202-10	1085.70 *		250	494	15
B-1400-HS-10-SS	†		500	87	37	E-1202-20	1085.70 *		250	494	15
B-1400-HS-20-SS	†		500	87	37	E-1202-10-PG	1135.45 *		250	494	15
B-1400-P-10	241.90 *		500	87	16	E-1202-20-PG	1135.45 *		250	494	15
B-1400-P-20	241.90 *		500	87	16	H-1200-10	578.20 *		500	305	15
B-1400-P-10-GR	247.85 *		500	87	16	H-1200-20	578.20 *		500	305	15
B-1400-P-20-GR	247.85 *		500	87	16	H-1200-HS-10	631.80 *		500	300	15
B-1400-P-10-HDG	363.15 *		500	85	16	H-1200-HS-20	631.80 *		500	300	15
B-1400-P-20-HDG	363.15 *		500	87	16	H-1200-HS-10-PG	670.35 *		500	300	15
B-1400-P-10-PG	247.85 *		500	87	16	H-1200-HS-20-PG	670.35 *		500	300	15
B-1400-P-20-PG	247.85 *		500	87	16	H-1202-10	1459.40 *		250	610	15
B-1400-S-10	247.60 *		500	85	16	H-1202-20	1459.40 *		200	610	15
B-1400-S-20	247.60 *		500	85	16						
B-1400-S-10-GR	270.70 *		500	85	16						
B-1400-S-20-GR	270.70 *		500	85	16						

Prices subject to change without notice.

†Contact Factory

***Prices standard packages are per pair.

Alphanumeric Price Sheet and Index (continued)

Catalog Number	Trade Price Per 100 Items or 100 Feet*		Std. Pkg. Qty.	Wt. Per 100 Pcs.	Page No.
	Standard Package				
Schedule B					
A-100-1/4	\$ 79.85		100	7	17
A-100-1/4-AL	†		100	3	37
A-100-1/4-SS	†		100	7	37
A-100-5/16	93.95		50	6	17
A-100-3/8	85.15		100	10	17
A-100-3/8-AL	†		100	3	37
A-100-3/8-SS	†		100	10	37
A-100-1/2	92.85		100	12	17
A-100-1/2-AL	†		100	3.6	37
A-100-1/2-SS	†		10	12	37
A-100-5/8	171.30		50	19	17
A-100-3/4	192.75		50	19	17
A-100-7/8	343.95		50	19	17
A-177-1/4X1	283.20		50	10	19
A-177-1/4X1-1/4	291.80		50	10	19
A-179-3/8X1	373.40		50	14	19
A-179-3/8X1-1/4	373.80		50	15	19
A-180-1/2X1	443.65		50	16	19
A-180-1/2X1-1/4	451.70		50	17	19
A-182-1/4X1	323.15		50	9	19
A-182-1/4X1-1/4	331.35		50	10	19
A-184-3/8X1	412.25		50	14	19
A-184-3/8X1-1/4	413.80		50	14	19
A-185-1/2X1	483.90		50	15	19
A-185-1/2X1-1/4	491.65		50	16	19
A-208	913.90		20	257	21
A-209	291.55		25	55	21
A-209-HDG	421.05†		50	55	21
A-210	273.10		25	88	21
A-211	653.35		10	128	21
A-212	711.60†		10	113	21
A-217	813.45		10	155	21
A-218	887.75		10	177	22
A-243-1	163.75		50	16	23
A-570	1117.30		1	220	28
A-597	513.85		25	108	28
A-597-HDG	744.75†		25	108	28
A-802	554.75		25	159	33
A-804	53.35		25	10	33
A-805	273.70		25	20	33
A-809-3/4	273.70		25	25	33
A-809-1	451.10		25	24	33
A-822	673.40		25	75	33
A-853	193.70		50	25	33
A-853-L	243.85		25	48	33
A-854	314.00		25	28	33
A-854-L	333.95		25	51	33
A-889	2042.25		10	120	35
A-890	2042.25		10	120	35
A-891	2573.85		10	140	35
A-892	2331.50		10	130	35
A-893	1693.85		10	110	35
AB-100-1/4	67.50		100	6	17
AB-100-1/4-SS	†		100	9	37
AB-100-5/16	77.75		50	6	17

Catalog Number	Trade Price Per 100 Items or 100 Feet*		Std. Pkg. Qty.	Wt. Per 100 Pcs.	Page No.
	Standard Package				
AB-100-3/8	\$ 68.85		100	9	17
AB-100-3/8-AL	†		100	2.5	37
AB-100-3/8-SS	†		100	9	37
AB-100-1/2	73.65		100	9	17
AB-100-1/2-SS	†		100	6	37
AB-100-5/8	140.25		50	10	17
AB-100-3/4	147.75		50	10	17
AB-102-1/4	91.80		100	13	17
AB-102-3/8	100.00		100	14	17
AB-102-1/2	103.20		100	14	17
AB-102-5/8	109.75		50	12	17
AB-102-3/4	118.30		50	11	17
AB-102-7/8	130.65		50	10	17
AB-201	121.65		50	35	20
AB-201-HDG	188.95†		50	35	20
AB-202	121.65		50	35	20
AB-202-HDG	188.95†		50	35	20
AB-202-SS	†		50	35	37
AB-203	173.00		50	58	20
AB-203-HDG	259.75†		50	58	20
AB-204	175.80		50	58	20
AB-204-HDG	263.85†		50	58	20
AB-205	340.25		25	78	20
AB-205-HDG	†		50	78	20
AB-205-SS	†		25	78	37
AB-206	127.75		50	35	20
AB-206-HDG	185.20†		50	38	20
AB-207	175.70		50	56	21
AB-213	610.20		10	125	21
AB-214	633.20		10	125	21
AB-216	788.55		10	135	21
AB-219	252.75		25	58	22
AB-220	338.55		25	78	22
AB-225	273.95		25	58	22
AB-227	271.15		50	58	22
AB-239-1	427.70		15	148	23
AB-239-2	893.85		10	240	23
AB-239-3	1037.30		10	363	23
AB-240	547.40		1	69	23
AB-241-1/4	71.50		100	18	23
AB-241-5/16	73.05		100	18	23
AB-241-3/8	73.95		100	18	23
AB-241-3/8-HDG	107.15†		100	18	23
AB-241-3/8-SS	†		100	18	37
AB-241-1/2	75.55		100	17	23
AB-241-1/2-HDG	109.45†		100	17	23
AB-241-1/2-SS	†		100	17	37
AB-241-5/8	77.75		100	15	23
AB-241-3/4	101.00		50	14	23
AB-242	88.55		50	17	23
AB-245	368.55		10	70	23
AB-252-1	276.95		50	61	23
AB-252-2	307.95		10	84	23
AB-252-3	339.10		10	84	23
AB-252-4	370.20		10	130	23

Prices subject to change without notice.
 †Contact Factory
 ***Prices standard packages are per pair.

Alphanumeric Price Sheet and Index (continued)

Catalog Number	Trade Price Per 100 Items or 100 Feet*		Std. Pkg. Qty.	Wt. Per 100 Pcs.	Page No.	Catalog Number	Trade Price Per 100 Items or 100 Feet*		Std. Pkg. Qty.	Wt. Per 100 Pcs.	Page No.
	Standard Package						Standard Package				
Schedule B (continued)											
AB-253	\$ 676.70		25	97	23	AB-871-P	\$ 3499.00		5	645	34
AB-254-L	542.75		10	105	24	AB-872-P	3499.00		5	632	34
AB-254-R	542.75		10	105	24	AB-873-P	3499.00		5	617	34
AB-255	365.55		10	70	24	AB-880	544.45		10	82	34
AB-257	474.45		25	105	24	AB-881	650.00		10	120	34
AB-260-L	336.05		25	58	24	AB-885	2478.15		25	24	35
AB-260-R	336.05		25	58	24	AB-887	2930.90		10	50	35
AB-261	802.70		10	148	24	AB-887-W/O	2246.80		10	39	35
AB-263	698.40		10	150	24	AB-888	2284.90		10	55	35
AB-265	581.70		10	105	24	AB-888-W/O	2250.45		10	37	35
AB-274	448.40		25	70	24	AC-100-1/4	71.50		50	6	17
AB-284-L	1647.15		1	230	25	AC-100-3/8	73.40		100	8	17
AB-284-R	1647.15		1	230	25	AC-100-1/2	79.30		50	11	17
AB-288-3/8	203.90		50	37	25	AC-100-5/8	133.55		50	18	17
AB-288-1/2	216.15		50	37	25	AC-100-3/4	147.75		50	18	17
AB-288-5/8	216.15		50	37	25	AN-211	872.60		10	181	21
AB-299	187.95		50	40	25	AN-270-1	556.90		10	113	24
AB-803	1379.65		25	63	33	AN-270-2	769.80		10	151	24
AB-815	2279.80		15	140	33	AN-270-3	995.45		10	199	24
AB-844	114.90		500	41	33	AN-270-4	1070.10		10	246	24
AB-844-PC	114.90		500	12	33	AN-270-5	1222.60		10	293	24
AB-840-P	1775.70		10	54	34	AP-232	1964.80		10	384	22
AB-841-P	1775.70		10	53	34	AP-235	2405.45		1	400	22
AB-842-P	1775.70		10	51	34	AW-204	444.80		25	76	20
AB-843-P	1851.25		10	94	34	AW-205-L	544.40		25	59	20
AB-844-P	1851.25		10	89	34	AW-205-R	544.40		25	59	20
AB-845-P	1851.25		10	84	34	AW-214	580.10		10	115	21
AB-846-P	1851.25		10	81	34	AW-219	1300.45		10	187	22
AB-847-P	1882.05		10	122	34	AW-220	720.20		20	90	22
AB-848-P	1882.05		10	119	34	AW-224	920.90		10	147	22
AB-849-P	1882.05		10	114	34	AW-226	709.30		20	113	22
AB-850-P	1882.05		10	111	34	AW-228	1241.15		10	230	22
AB-851-P	1959.80		10	238	34	B-100-1/4	85.70		100	6	17
AB-852-P	1959.80		10	232	34	B-100-1/4-SS	†		100	7	17
AB-853-P	1959.80		10	221	34	B-100-5/16	94.90		50	8	17
AB-854-P	1959.80		10	217	34	B-100-3/8	86.10		100	9	17
AB-855-P	2034.80		10	274	34	B-100-3/8-SS	†		100	7	17
AB-856-P	2034.80		10	267	34	B-100-1/2	92.75		100	8	17
AB-857-P	2034.80		10	259	34	B-100-1/2-SS	†		100	7	17
AB-858-P	2034.80		10	252	34	B-209	225.45		25	43	21
AB-859-P	2561.15		10	347	34	B-210	340.65		25	65	21
AB-860-P	2561.15		10	336	34	B-302-10	486.90 *		1	139	26
AB-861-P	2561.15		10	325	34	B-302-20	486.90 *		1	139	26
AB-862-P	2561.15		10	314	34	B-802	525.70		25	112	33
AB-863-P	3197.75		10	495	34	B-804	39.55		25	5	33
AB-864-P	3197.75		10	480	34	B-822	641.90		25	56	33
AB-865-P	3197.75		10	465	34	C-209	241.05		25	49	21
AB-866-P	3197.75		5	450	34	C-210	457.15		10	77	21
AB-866	254.10		100	6	34	C-302-10	488.00		360	195	26
AB-867	291.70		25	24	34	C-302-20	488.00		720	195	26
AB-867-P	3197.75		5	712	34	C-450	146.95		50	30	26
AB-868	46.60		100	3	34	C-708U-1/2	262.75		50	23	31
AB-868-P	3499.00		5	696	34	C-708U-3/4	278.50		50	26	31
AB-869-P	3499.00		5	683	34	C-708U-1	293.95		50	31	31
AB-870-P	3499.00		5	670	34	C-708U-1-1/4	304.80		25	35	31

Prices subject to change without notice.
 †Contact Factory
 ***Prices standard packages are per pair.

Alphanumeric Price Sheet and Index (continued)

Catalog Number	Trade Price Per 100 Items or 100 Feet*		Std. Pkg. Qty.	Wt. Per 100 Pcs.	Page No.
	Standard Package				
Schedule B (continued)					
C-708U-1-1/2	\$ 314.75		25	39	31
C-708U-2	563.50		25	94	31
C-708U-2-1/2	602.15		25	114	31
C-708U-3	662.15		25	133	31
C-708U-3-1/2	704.40		25	152	31
C-708U-4	749.30		25	176	31
C-708U-5	838.20		10	198	31
C-708U-6	1023.20		10	246	31
C-749-N	1321.10		50	61	25
C-749-N-5/8	1513.05		25	67	25
C-749-N-7/8	1513.05		25	74	25
C-749-N-1-1/8		†	25	72	25
C-775-L-3/8	303.15		50	33	29
C-775-L-3/8-B	193.35		50	35	29
C-775-L-3/8-SS		†	50	38	37
C-775-L-1/2	365.10		50	41	29
C-775-L-1/2-B	243.65		50	41	29
C-775-L-5/8	552.05		50	67	29
C-775-L-5/8-B	481.00		50	67	29
C-775-L-3/4	757.70		50	71	29
C-775-L-3/4-B	651.45		50	71	29
C-775-L-7/8	1303.35		50	163	29
C-775-L-7/8-B	1151.95		50	163	29
C-775-L-1/2-SS		†	50	41	37
C-781-3/8	781.45		25	62	29
C-781-1/2	781.45		25	62	29
C-781-5/8	1121.30		25	91	29
C-781-3/4	1121.30		25	164	29
C-804	47.70		25	8	33
C-805	271.70		25	20	33
C-822	771.35		25	70	33
CM-100-1/4	87.75		100	7	17
CM-100-3/8	87.65		100	10	17
CM-100-1/2	94.85		100	12	17
CM-100-B-1/2	94.65		100	7	17
CZ-209	341.40		25	70	21
E-120-3/8	514.75		25	15	18
E-120-1/2	567.60		25	29	18
E-122-3/8	933.75		25	30	18
E-122-1/2	1212.40		10	58	18
E-130-3/8	547.40		25	20	18
E-130-1/2	607.95		25	38	18
E-131-1/2	1157.25		10	67	18
E-131-3/8	1043.30		25	35	18
E-142-1/4X1	131.95		100	2	18
E-142-1/2X1-SS		†	100	9	37
E-142-1/4X1-1/4	111.75		50	2	18
E-142-1/4X1-1/2	211.20		50	2	18
E-142-1/4X2-1/4	37.25		50	3	18
E-142-1/4X3-1/4	51.45		50	4	18
E-142-1/4X3-1/2	57.40		50	4	18
E-142-1/4X4	63.75		50	5	18
E-142-3/8X3/4	21.80		50	4	18
E-142-3/8X1	23.20		50	4	18
E-142-3/8X1-SS		†	50	4	37

Catalog Number	Trade Price Per 100 Items or 100 Feet*		Std. Pkg. Qty.	Wt. Per 100 Pcs.	Page No.
	Standard Package				
E-142-3/8X1-1/4	\$ 28.05		50	5	18
E-142-3/8X1-1/4-SS		†	50	5	37
E-142-3/8X1-1/2	31.15		50	6	18
E-142-3/8X1-1/2-SS		†	50	6	37
E-142-3/8X2-1/4	43.55		50	6	18
E-142-1/2X15/16	44.75		50	9	18
E-142-1/2X1-SS		†	100	8	37
E-142-1/2X1-1/4	49.75		50	9	18
E-142-1/2X1-1/2	56.15		50	10	18
E-142-1/2X2	71.50		50	13	18
E-142-1/2X2-1/2	82.50		50	15	18
E-145-1/4	6.15		100	1	18
E-145-3/8	10.15		100	2	18
E-145-1/2	23.30		100	4	18
E-145-5/8	38.85		50	7	18
E-145-3/4	77.75		100	12	18
E-145-7/8	104.20		50	19	18
E-145-1	179.90		50	28	18
E-146-1/4	7.60		100	1	18
E-146-5/16	9.40		100	2	18
E-146-3/8	13.95		100	3	18
E-146-1/2	37.25		100	6	18
E-146-5/8	97.40		50	11	18
E-147-1/4	5.70		100	1	18
E-147-5/16	8.95		100	1	18
E-147-3/8	9.10		100	2	18
E-147-1/2	13.95		100	5	18
E-147-5/8	31.15		50	8	18
E-147-3/4	45.10		50	10	18
E-147-7/8	49.75		50	15	18
E-148-1/4	3.20		100	1	19
E-148-5/16	4.75		100	1	19
E-148-3/8	7.75		100	1	19
E-148-1/2	13.95		100	1	19
E-148-5/8	31.15		100	2	19
E-149-1/4X3/4	9.40		50	1	19
E-149-1/4X1	10.80		50	2	19
E-149-5/16X1-1/4	23.40		50	3	19
E-149-3/8X1-1/4	29.65		50	5	19
E-150S-3/8X1-1/2	65.95		50	5	19
E-150S-3/8X2	80.70		50	7	19
E-150S-3/8X2-1/2	91.80		50	8	19
E-150S-3/8X3	111.45		50	9	19
E-150S-1/2X1-1/2	69.65		50	12	19
E-150S-1/2X2	117.30		50	13	19
E-150S-1/2X2-1/2	141.25		50	16	19
E-150S-1/2X3	164.90		50	18	19
E-210	622.30		10	112	21
E-802	1444.55		25	170	33
E-804	144.80		25	20	33
E-805	297.85		25	30	33
EF-147-1/4	23.65		100	3	19
EF-147-3/8	23.60		100	3	19
EF-147-1/2	32.35		100	5	19
EN-145-1/4	9.40		100	1	18

Prices subject to change without notice.
 †Contact Factory
 ***Prices standard packages are per pair.

Alphanumeric Price Sheet and Index (continued)

Catalog Number	Trade Price Per 100 Items or 100 Feet*		Std. Pkg. Qty.	Wt. Per 100 Pcs.	Page No.
	Standard Package				
Schedule B (continued)					
EN-145-3/8	\$ 12.40		1	2	18
ES-142-1/2X1-1/2	314.10		50	21	18
ES-145-3/8	171.35		50	6	18
ES-145-1/2	181.00		50	6	18
EZ-209	376.35		25	67	21
ii-100-3/8	118.30		50	10	17
H-100-1/2	126.00		50	14	17
H-104-1/4X6	27.40		300	12	17
H-104-1/4X6B	23.40		300	12	17
H-104-1/4X10	27.40		500	12	17
H-104-1/4-X-10B	23.40!		500	12	17
H-104-1/4-X-12	27.40!		180	12	17
H-104-1/4X12B	25.80		180	12	17
H-104-3/8X6	42.35		150	29	17
H-104-3/8X6B	34.40		150	29	17
H-104-3/8X10	42.35		250	29	17
H-104-3/8X10B	34.40		250	29	17
H-104-3/8X12	42.35		180	29	17
H-104-3/8X12B	38.15		180	29	17
H-104-3/8X12SS	†		300	29	37
H-104-1/2X6	77.85		60	54	17
H-104-1/2X6B	68.65		60	--	17
H-104-1/2X10	77.85		100	54	17
H-104-1/2X10B	62.00		100	54	17
H-104-1/2X12	77.85		60	54	17
H-104-1/2X12B	68.65		60	54	17
H-104-1/2X12SS	†		156	54	37
H-104-5/8X6	115.60		30	83	17
H-104-5/8X6B	102.25		30	83	17
H-104-5/8X10	115.60		50	83	17
H-104-5/8X10B	92.35		50	83	17
H-104-5/8X12	115.60		60	83	17
H-104-5/8X12B	102.25		60	83	17
H-104-3/4X6	204.10		60	125	17
H-104-3/4X6B	161.80		60	125	17
H-104-3/4X10	186.90		60	125	17
H-104-3/4X10B	146.00		60	125	17
H-104-3/4X12	186.90		120	125	17
H-104-3/4X12B	161.80		120	125	17
H-104-7/8X10	642.60		50	165	17
H-104-7/8X10B	633.85		50	165	17
H-104-7/8X12	642.60		60	165	17
H-104-7/8X12B	633.85		60	165	17
H-104-1X6	997.25		30	225	17
H-104-1X10	997.25		50	225	17
H-104-1X12	997.25		60	225	17
H-119-1/4	87.35		50	6	18
H-119-5/16	138.40		50	18	18
H-119-3/8	140.65		50	11	18
H-119-1/2	179.10		50	11	18
H-119-5/8	286.05		50	18	18
H-119-3/4	416.55		50	30	18
H-119-7/8	853.95		50	96	18
H-119-1	1101.15		50	94	18
H-119-1/4X3/8	149.65		50	4	18

Catalog Number	Trade Price Per 100 Items or 100 Feet*		Std. Pkg. Qty.	Wt. Per 100 Pcs.	Page No.
	Standard Package				
H-119-3/8X1/2	\$ 205.25		50	6	18
H-119-1/2X5/8	295.55		50	12	18
H-119-5/8X3/4	432.40		50	21	18
H-119-3/4X7/8	547.40		50	75	18
H-802	1144.90		25	182	33
H-804	152.15		25	19	33
H-805	307.95		25	31	33
M-775-L-3/8	216.95		25	42	29
M-775-L-3/8-B	131.95		25	42	29
M-775-L-1/2	273.05		25	49	29
M-775-L-1/2-B	166.95		25	49	29
M-775-L-5/8-B	256.15		25	62	29
M-775-L-3/4-B	347.70		25	87	29
M-777-3/8	130.25		25	30	29
M-777-3/8-B	102.95		25	30	29
M-777-1/2	176.60		25	36	29
M-777-1/2-B	137.15		25	36	29
M-778-3/8	195.55		25	44	29
M-778-3/8-B	140.65		25	44	29
M-778-1/2	246.95		25	36	29
M-778-1/2-B	193.75		25	42	29
M-778-5/8	425.20		25	45	29
M-778-5/8-B	361.80		25	45	29
M-778-3/4-B	461.15		25	67	29
PG-795	261.25		25	40**	32
Q-202	889.65		20	68	20
Q-205	1900.65		25	109	20
Q-252-1-1/4	3088.40		10	305	23
Q-252-2	2513.40		10	405	23
Q-253	3088.40		10	205	23
Q-254	3088.40		10	205	24
Q-255	1315.80		10	234	24
Q-256	1315.80		10	234	24
S-201L-6	436.95		1	67	20
S-201L-8	523.05		1	92	20
S-201L-10	613.40		1	120	20
S-201L-12	761.90		1	152	20
S-201L-14	857.05		5	173	20
S-201L-16	1017.15		1	223	20
S-201L-18	1186.80		1	266	20
S-201L-20	1365.70		1	308	20
S-201R-6	439.00		1	67	20
S-201R-8	523.05		1	92	20
S-201R-10	613.40		1	120	20
S-201R-12	848.20		1	152	20
S-201R-14	857.05		5	173	20
S-201R-16	1017.15		1	223	20
S-201R-18	1186.80		1	266	20
S-201R-20	1365.70		1	308	20
S-204	1111.95		1	174	20
S-205	1421.50		1	264	20
S-217	1762.25		1	264	22
S-218	1983.15		1	295	22
S-222	2541.45		1	385	22
S-226	3288.15		1	421	22

Prices subject to change without notice.

†Contact Factory

**Prices standard packages are per pair.

Alphanumeric Price Sheet and Index (continued)

Catalog Number	Trade Price Per 100 Items or 100 Feet*		Std. Pkg. Qty.	Wt. Per 100 Pcs.	Page No.
	Standard Package				
Schedule B (continued)					
S-236	\$ 4007.70		1	744	22
S-247	1699.75		1	229	23
S-248	1913.90		1	272	23
S-250-6	1336.05		1	150	23
S-250-12	1352.85		1	250	23
S-250-18	1493.65		1	350	23
S-250-24	1710.45		1	450	23
S-251-12	3033.15		1	514	23
S-251-18	3320.80		1	714	23
S-251-24	3914.90		1	914	23
S-251-30	4444.00		1	1114	23
S-251-36	4722.30		1	1314	23
S-256-6	1131.00		1	151	24
S-256-12	1353.95		1	251	24
S-256-18	1488.60		1	351	24
S-256-24	3091.90		1	451	24
S-541-3/8	342.25		25	31	27
S-720-3/4	1003.20		10	136	32
S-720-1	1023.95		10	138	32
S-720-1-1/4	1237.95		10	195	32
S-720-1-1/2	1266.50		10	201	32
S-720-2	1066.90		10	217	32
S-720-2-1/2	1396.70		10	229	32
S-720-3	1533.20		10	250	32
S-720-3-1/2	1964.80		10	330	32
S-720-4	2047.30		10	342	32
S-720-5	3031.35		10	493	32
S-720-6	3444.10		10	526	32
S-720-8	5672.30		5	986	32
S-720-10	6268.95		1	1100	32
S-720-12	9443.30		1	1660	32
TR-292	1918.40		20	59	25
TR-294	3590.45		10	106	25
TS-272	690.65		10	104	24
TS-273	1038.95		10	228	24
U-501	344.05		20	90	27
U-501-HDG	453.10		20	90	27
U-501-SS	†		20	90	37
U-502	431.35		20	100	27
U-502-HDG	†		20	100	27
U-502-SS	†		20	100	37
U-504	735.65		25	140	18
U-505	1594.20		1	270	18
U-510	685.80		25	75	18
U-514	414.75		50	39	18
U-514-HDG	601.05†		50	39	18
U-514A	471.35		50	59	18
U-514A-HDG	683.15†		50	59	18
U-515	598.85		25	95	18
U-515B	664.30		25	95	18
U-515-HDG	962.75†		25	95	18
U-520	2222.60		10	328	18
U-521	†		10	343	18
U-522	2342.40		10	353	18
U-560-1/4	715.55		25	67	19

Catalog Number	Trade Price Per 100 Items or 100 Feet*		Std. Pkg. Qty.	Wt. Per 100 Pcs.	Page No.
	Standard Package				
U-560-3/8	\$ 723.30		25	67	19
U-560-1/2	995.45		25	130	19
U-560-5/8	1180.25		25	130	19
U-562	471.90		25	80	19
U-562-HDG	683.85†		25	80	19
U-563	288.80		25	33	19
U-564-3/8	1180.20		25	109	19
U-564-1/2	1633.15		15	201	19
U-564-5/8	1633.15		15	201	19
U-568-1	193.55		25	18	19
U-568-2	226.50		25	25	19
U-568-3	191.95		25	24	19
U-568-4	221.00		25	33	19
U-568-5	231.15		25	42	19
U-568-6	186.60		25	26	19
U-568-7	210.10		25	35	19
U-568-8	221.80		25	44	19
U-569	970.80		25	150	19
U-571	164.20		25	39	19
U-572	337.25		25	40	19
U-576-3/8	552.15		25	36	20
U-576-1/2	552.15		25	36	20
U-577	933.30		25	69	20
U-579-3/8	162.75		25	30	20
U-579-1/2	217.75		25	50	20
U-861-1	2328.15		1	84	28
U-861-2	3826.50		1	102	28
U-861-3	3973.75		1	121	28
U-861-4	4004.00		1	165	28
U-861-5	4354.10		1	189	28
U-861-6	4494.20		1	215	28
U-861-7	7281.25		1	243	28
U-861-8	9089.90		1	270	28
US-562	484.45		50	113	19
US-563	520.90		25	50	19
X-201	432.40		25	65	11
X-204	1016.15		25	190	11
X-207	247.40		50	78	12
X-208	365.55		25	88	12
X-289	609.75		25	105	16
X-299	261.25		25	38	16
452	132.65		50	52	26
460-10	49.55		500	4	26
512	183.20		50	26	27
540-3/8	107.90		25	40	27
540-3/8B	107.60		25	38	27
540-1/2	187.60		25	36	27
540-1/2B	185.10		25	25	27
540-5/8	223.95		25	84	27
540-5/8B	202.15		25	84	27
540-3/4	287.70		25	113	27
540-3/4B	256.60		25	113	27
540-7/8	435.65		25	106	27
540-7/8B	396.60		25	106	27
811-1	143.05		50	8	33

Prices subject to change without notice.
 †Contact Factory
 ***Prices standard packages are per pair.

Alphanumeric Price Sheet and Index (continued)

Catalog Number	Trade Price Per 100 Items or 100 Feet*		Std. Pkg. Qty.	Wt. Per 100 Pcs.	Page No.	Catalog Number	Trade Price Per 100 Items or 100 Feet*		Std. Pkg. Qty.	Wt. Per 100 Pcs.	Page No.
	Standard Package						Standard Package				
Schedule B (continued)											
811-2	\$ 143.05		50	9	33	701-3-1/2	\$ 289.20		25	47	30
						701-3-5/8	280.15		25	56	30
						701-3-3/4	307.95		25	58	30
						701-3-7/8	365.55		25	60	30
						701-4	371.80		25	62	30
Schedule C											
CT-701-3/8	150.90		100	8	22	701-4-1/8	370.95		25	62	30
CT-701-1/2	147.75		100	9	22	701-4-1/4	388.75		25	64	30
CT-701-5/8	132.40		100	10	22	701-4-3/8	356.85		25	66	30
CT-701-3/4	174.00		100	11	22	701-4-1/2	415.45		10	67	30
						701-4-5/8	419.10		10	70	30
CT-701-7/8	142.00		100	12	22	701-4-3/4	421.50		10	72	30
CT-701-1-1/8	171.55		100	15	22	701-4-7/8	429.30		10	70	30
CT-701-1-3/8	180.25		100	17	22	701-5	440.10		10	74	30
CT-701-1-5/8	188.80		100	19	22	701-5-1/8	449.45		10	76	30
CT-701-2-1/8	257.05		50	32	22	701-5-1/4	458.85		10	77	30
CT-701-2-5/8	303.20		50	37	22	701-5-3/8	466.60		10	78	30
CT-701-3-1/8	334.45		50	43	22	701-5-1/2	482.15		10	79	30
CT-701-3-5/8	373.40		50	56	22	701-5-5/8	517.85		10	88	30
CT-701-4-1/8	458.85		25	62	22	701-5-3/4	531.90		10	90	30
700-3/8	79.90		100	12	30	701-5-7/8	542.75		10	92	30
700-1/2	82.65		100	12	30	701-6	552.15		10	94	30
700-3/4	93.65		100	13	30	701-6-1/8	590.20		10	96	30
700-1	99.10		100	16	30	701-6-1/4	626.35		10	98	30
700-1-1/4	115.60		50	19	30	701-6-3/8	635.00		10	99	30
700-1-1/2	130.90		50	29	30	701-6-1/2	639.45		10	100	30
700-2	148.85		50	33	30	701-6-5/8	645.70		10	102	30
701-1/4	107.05		100	8	30	701-6-3/4	649.00		10	104	30
701-1/4-SS	†		100	8	38	701-6-7/8	650.45		10	106	30
701-3/8	110.00		100	8	30	701-7	651.35		10	108	30
701-3/8-SS	†		100	8	38	701-7-1/8	653.30		10	110	30
701-1/2	104.65		100	9	30	701-7-1/4	661.00		10	112	30
701-1/2-SS	†		100	13	38	701-7-3/8	675.00		10	114	30
701-5/8	106.10		100	10	30	701-7-1/2	681.25		10	116	30
701-3/4	117.40		100	11	30	701-7-5/8	690.65		10	117	30
701-7/8	115.60		100	12	30	701-7-3/4	698.40		10	119	30
701-1	144.80		50	14	30	701-7-7/8	710.90		10	121	30
701-1-1/8	130.90		100	15	30	701-8	718.55		10	123	30
701-1-1/4	150.90		25	16	30	701-8-1/8	726.25		10	125	30
701-1-3/8	137.85		100	17	30	701-8-1/4	735.65		10	126	30
701-1-1/2	158.75		25	18	30	701-8-3/8	746.60		10	128	30
701-1-5/8	143.25		100	19	30	701-8-1/2	757.40		10	129	30
701-1-3/4	186.60		25	28	30	701-8-5/8	769.80		10	130	30
701-1-7/8	210.10		50	29	30	701-12	1004.10		1	300	30
701-2	216.15		50	31	30	702-3/8	90.20		100	10	31
701-2-1/8	222.50		50	32	30	702-3/8-HDG	0.00		100	10	31
701-2-1/4	228.65		25	33	30	702-1/2	82.65		100	11	31
701-2-3/8	233.40		25	34	30	702-1/2-AL	147.15		100	4	37
701-2-1/2	237.95		25	35	30	702-1/2-HDG	128.60		100	11	31
701-2-5/8	219.10		50	37	30	702-1/2-SS	0.00		100	11	38
701-2-3/4	250.45		50	38	30	702-1-1/2-SS	544.40		50	29	38
701-2-7/8	256.60		25	40	30	702-3/4	93.65		100	14	31
701-3	264.40		25	41	30	702-3/4-AL	154.80		100	5	37
701-3-1/8	239.75		25	43	30	702-3/4-HDG	137.65		100	15	31
701-3-1/4	273.95		25	45	30	702-3/4-SS	†		100	15	38
701-3-3/8	281.60		25	46	30	702-1	99.10		100	17	31

Prices subject to change without notice.
 †Contact Factory
 ***Prices standard packages are per pair.

Alphanumeric Price Sheet and Index (continued)

Catalog Number	Trade Price Per 100 Items or 100 Feet*		Std. Pkg. Qty.	Wt. Per 100 Pcs.	Page No.
	Standard Package				
Schedule C (continued)					
702-1-AL	\$ 177.25		100	7	37
702-1-HDG	156.10		100	17	31
702-1-SS	†		100	17	38
702-1-1/4	115.60		50	18	31
702-1-1/4-AL	205.65		100	6	37
702-1-1/4-HDG	179.90		100	18	31
702-1-1/4-SS	†		50	18	38
702-1-1/2	130.90		50	29	31
702-1-1/2-AL	275.35		100	11	37
702-1-1/2-HDG	205.60		100	29	31
702-2	148.85		50	24	31
702-2-AL	411.50		25	12	37
702-2-HDG	233.25		50	34	31
702-2-SS	†		50	34	38
702-2-1/2	174.55		50	40	31
702-2-1/2-AL	289.30		25	14	37
702-2-1/2-HDG	269.90		50	40	31
702-2-1/2-SS	†		25	40	38
702-3	190.60		50	47	31
702-3-AL	509.40		25	17	37
702-3-HDG	295.35		50	47	31
702-3-SS	†		25	47	38
702-3-1/2	224.40		25	62	31
702-3-1/2-AL	384.55		25	21	37
702-3-1/2-HDG	348.10		25	62	31
702-3-1/2-SS	†		25	62	38
702-4	249.30		25	67	31
702-4-AL	451.45		10	23	37
702-4-HDG	387.25		25	69	31
702-4-SS	†		25	67	38
702-5	332.85		25	80	31
702-5-HDG	0.00				31
702-5-SS	†		25	80	38
702-6	444.80		10	102	31
702-6-AL	741.35†		10	24	37
702-6-SS	†		10	102	38
702-8	581.70		10	130	31
702-8-AL	969.55†		10	25	37
702-8-SS	†		10	130	38
702-10	965.65		10	160	31
702-12	943.85		10	190	31
703-1/2	82.65		100	15	31
703-3/4	93.65		100	16	32
703-1	99.10		100	18	31
703-1-1/4	115.60		50	22	31
703-1-1/2	130.90		50	29	31
703-2	148.85		50	34	31
Schedule F					
A-716-1/4	325.85		25	10	31
A-716-3/8	325.85		25	11	31
A-716-1/2	322.85		25	13	31

Catalog Number	Trade Price Per 100 Items or 100 Feet*		Std. Pkg. Qty.	Wt. Per 100 Pcs.	Page No.
	Standard Package				
Schedule F (continued)					
A-716-5/8	\$ 332.00		25	14	31
A-716-3/4	386.40		25	14	31
A-716-7/8	421.90		25	15	31
A-716-1	491.55		10	17	31
A-716-1-1/8	489.60		10	18	31
A-716-1-1/4	577.60		10	18	31
A-716-1-3/8	579.35		10	20	31
A-716-1-1/2	725.85		10	33	31
A-716-1-5/8	760.40		10	35	31
A-716-1-3/4	997.05		10	37	31
A-716-1-7/8	1170.80		10	39	31
A-716-2	1344.50		10	41	31
A-716-2-1/8	1404.90		10	46	31
A-716-2-3/8	1632.65		10	47	31
A-716-2-5/8	1623.25		10	51	31
A-716-3-1/8	2119.90		10	60	31
A-716-4-1/8	4308.95		10	94	31
P-716-1/4	405.00		25	13.0	24
P-716-3/8	423.70		25	14.0	24
P-716-1/2	523.30		25	15.0	24
P-716-3/4	554.40		25	17.0	24
P-716-1	735.15		20	19.0	24
P-716-1-1/4	1059.15		10	35.0	24
P-716-1-1/2	1138.30		10	39.0	24
P-716-2	1925.15		10	47.0	24
P-716-2-1/2	2548.30		10	55.0	24
P-716-3	3725.85		10	64.0	24
P-716-3-1/2	5283.55	bulk		88.0	24
P-716-4	6080.95	bulk		110.0	24
S-716	6381.25		20	260	24
U-716-1/4	318.35		25	3	24
U-716-3/8	332.15		25	4	24
U-716-1/2	332.15		25	6	24
U-716-5/8	332.15		25	6	24
U-716-3/4	338.85		25	7	24
U-716-7/8	352.90		25	7	24
U-716-1	382.00		25	8	24
U-716-1-1/8	404.85		25	8	24
U-716-1-1/4	507.40		10	17	24
U-716-1-3/8	520.50		10	20	24
U-716-1-1/2	527.60		10	20	24
U-716-1-5/8	542.05		10	23	24
U-716-1-3/4	607.15		10	32	24
U-716-1-7/8	628.95		10	34	24
U-716-2	650.45		10	36	24
U-716-2-1/8	701.10		10	41	24
U-716-2-3/8	†		10	46	24
U-717-3/4	390.35		25	8	24
U-717-1	513.30		10	20	24
U-717-1-1/4	578.20		10	32	24

Prices subject to change without notice.
 †Contact Factory
 ***Prices standard packages are per pair.

Alphanumeric Price Sheet and Index (continued)

Catalog Number	Trade Price Per 100 Items or 100 Feet*		Std. Pkg. Qty.	Wt. Per 100 Pcs.	Page No.	Catalog Number	Trade Price Per 100 Items or 100 Feet*		Std. Pkg. Qty.	Wt. Per 100 Pcs.	Page No.
	Standard Package						Standard Package				
Schedule S											
RA-BN-5/8	\$ 26.05 **		500	4	30						
RA-BN-3/4	28.85 **		100	5	30						
RA-C	356.20 ***		1	17	30						
RA-GP	67.95		25	10	30						
RA-RC	29.45 ***		2	2	30						
RA-SC	40.65 ***		2	2	30						
RA-160-10	141.50 *		50	76	30						
RA-160-12	141.50 *		60	76	30						
RA-225-10	164.35 *		50	92	30						
RA-225-12	164.35 *		60	92	30						
RA-300-10	230.90 *		50	92	30						
RA-300-12	230.90 *		60	144	30						

Prices subject to change without notice.

†Contact Factory

***Prices standard packages are per pair.

Catalog Number	Wt./ 100 Ft. Bundle	Ft./ Page	Eng. Cat. Page	Price Per 100 FT.			
				EC	GR	PG	HDG

Catalog Number	Wt./ 100 Ft. Bundle	Ft./ Page	Eng. Cat. Page	Price Per 100 FT.			
				EC	GR	PG	HDG

CHANNELS

Superstrut 12-Gauge Channel Type A 1½" x 1½"

A-1200

A-1200-HS
Slots 2" on center
Slot Size ½" x 1¼"

A-1200-P
Hole Size ½"

A-1200-KO
KO for ½" conduit

A-1200-S
¾" x 3" slots on 4" centers

A-1200	190	500	6	\$ 294.75	\$ 297.40	\$ 297.40	\$ 456.45
A-1200-HS	185	500	6	316.35	320.40	320.40	508.50
A-1200-P	185	500	6	324.50	328.90	328.90	508.50
A-1200-KO	190	500	6	334.35	†	†	†
A-1200-S	180	500	6	331.35	341.65	341.65	

Superstrut 12-Gauge Channel Type A 1½" x 1½"

A-1203-A

A-1203-B

A-1203-C

A-1203-D

A-1203-A	570	bulk	7	†	†	†	†
A-1203-B	570	bulk	7	†	†	†	†
A-1203-C	570	bulk	7	†	†	†	†
A-1203-D	570	bulk	7	†	†	†	†

A-1202

A-1202-HS

A-1202-A

A-1202-B

A-1202-C

A-1202	380	250	7	\$ 630.10	\$ 642.70	\$ 712.00	\$ 1000.10
A-1202-HS	370	250	7	852.30	†	931.50	1271.95
A-1202-A	380	250	7	†	†	†	†
A-1202-B	380	250	7	†	†	†	†
A-1202-C	380	250	7	†	†	†	†

A-1204

A-1204	760	bulk	7	†	†	†	†
--------	-----	------	---	---	---	---	---

EXAMPLE OF CATALOG NUMBER

A-1200-HS- 10 - HDG
Item Length Finish

* Available in 10' and 20' lengths
† Contact Factory

Catalog Number	Wt./ 100 Ft. Bundle	Ft./ Page	Eng. Cat.	Price Per 100 FT.			
				EC	GR	PG	HDG

CHANNELS (continued)

Superstrut 12-Gauge Channel Type B 1 5/8" x 1 3/16"***

B-1200

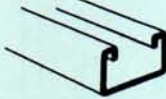

B-1200-HS

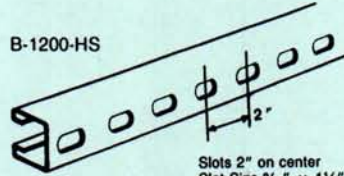

Slots 2" on center
Slot Size 5/16" x 1/4"

B-1200-P

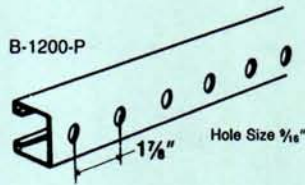

Hole Size 5/16"

B-1200-S

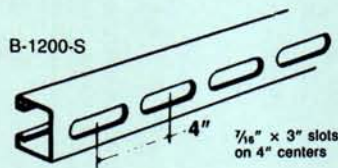

7/16" x 3" slots
on 4" centers

B-1202

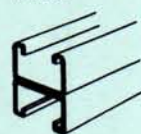

B-1200	128	500	6	\$ 242.10	\$ 264.05	\$ 264.05	\$ 383.55
B-1200-HS	123	500	6	267.85	291.90	291.90	415.90
B-1200-P	123	500	6	275.85	300.60	300.60	435.65
B-1200-S	118	500	6	281.25	†	307.95	436.70
B-1202	256	250	7	528.00	†	533.80	792.70

Superstrut 12-Gauge Channel Type C 1 5/8" x 1 3/16"***

C-1200

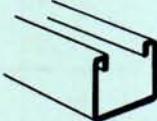

C-1200-HS

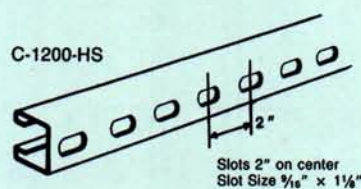

Slots 2" on center
Slot Size 5/16" x 1/4"

C-1202



C-1202-A

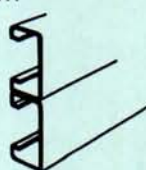

C-1202-B

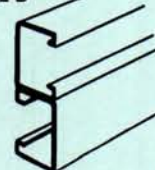

C-1200	170	500	6	\$ 305.15	†	\$ 325.90	\$ 458.15
C-1200-HS	165	500	6	334.50	†	357.15	502.15
C-1202-10	340	250	7	706.05	†	727.85	1023.30
C-1202-A	340	250	7	†	†	†	†
C-1202-B	340	250	7	†	†	†	†

Catalog Number	Wt./ 100 Ft. Bundle	Ft./ Page	Eng. Cat.	Price Per 100 FT.			
				EC	GR	PG	HDG

Superstrut 12-Gauge Channel Type E 1 5/8" x 2 7/16"***

E-1200

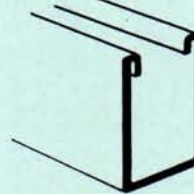

E-1200-HS

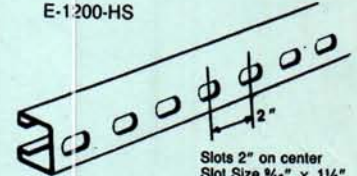

Slots 2" on center
Slot Size 5/16" x 1/4"

E-1202

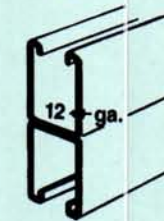

E-1200	247	500	6	\$ 463.55	\$ 475.25	†	\$ 695.80
E-1200-HS	242	500	6	486.90	†	539.75	730.90
E-1202	494	250	7	1085.70	†	1135.45	†

Superstrut 12-Gauge Channel Type H 1 5/8" x 3 1/4"***

H-1200



H-1200-HS

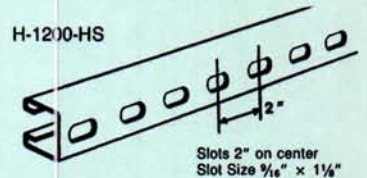

Slots 2" on center
Slot Size 5/16" x 1/4"

H-1202



H-1200	305	500	6	578.20	†	†	†
H-1200-HS	300	500	6	531.80	†	670.35	†
H-1202	610	250	7	1459.40	†	†	†

*Available in 10' and 20' lengths
†Contact Factory

Catalog Number	Wt./ 100 Ft. Bundle	Fl./ Bundle	Eng. Cat. Page	Price Per 100 FT.			
				EC	GR	PG	HDG

CHANNELS (continued)

Superstrut 14-Gauge Channel Type A 1 1/2" x 1 1/2"*

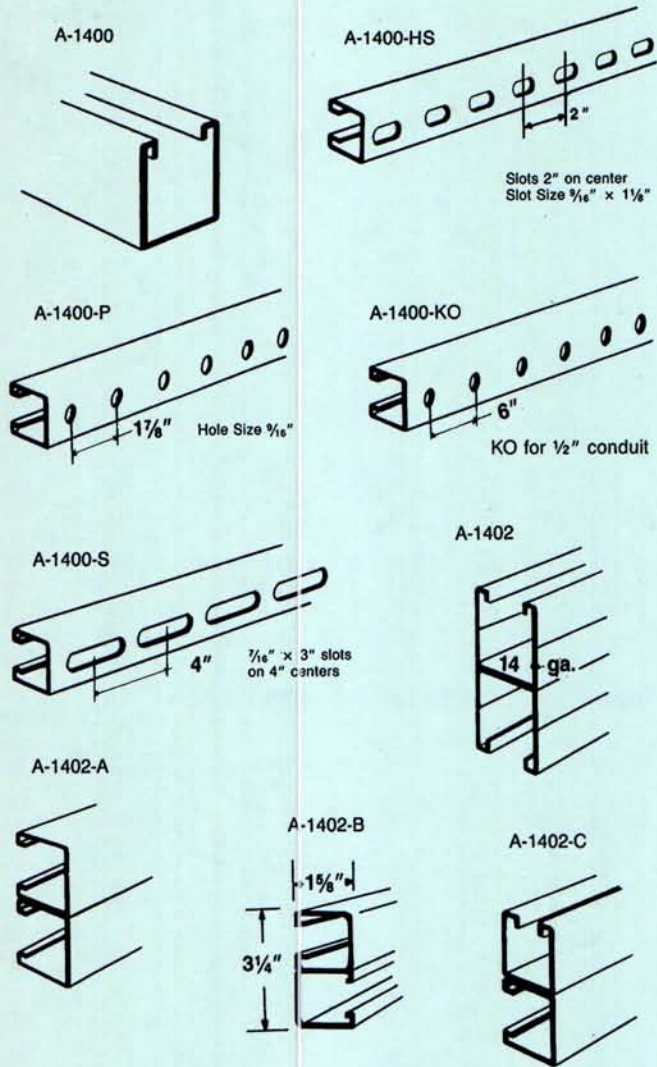

A-1400	140	500	6	\$ 253.50	\$ 254.90	\$ 254.90	\$ 393.55
A-1400-HS	136	500	6	281.00	283.85	283.85	436.05
A-1400-P	136	500	6	313.90	†	315.35	471.15
A-1400-KO	140	500	6	319.75	†	321.10	†
A-1400-S	137	500	6	300.40	†	321.10	466.50
A-1402	280	250	7	620.55	†	639.75	899.30
A-1402-A	280	250	†	†	†	†	†
A-1402-B	280	250	†	†	†	†	†
A-1402-C	280	250	†	†	†	†	†

Catalog Number	Wt./ 100 Ft. Bundle	Fl./ Bundle	Eng. Cat. Page	Price Per 100 FT.			
				EC	GR	PG	HDG

Superstrut 14-Gauge Channel Type B 1 1/2" x 1 3/16"*

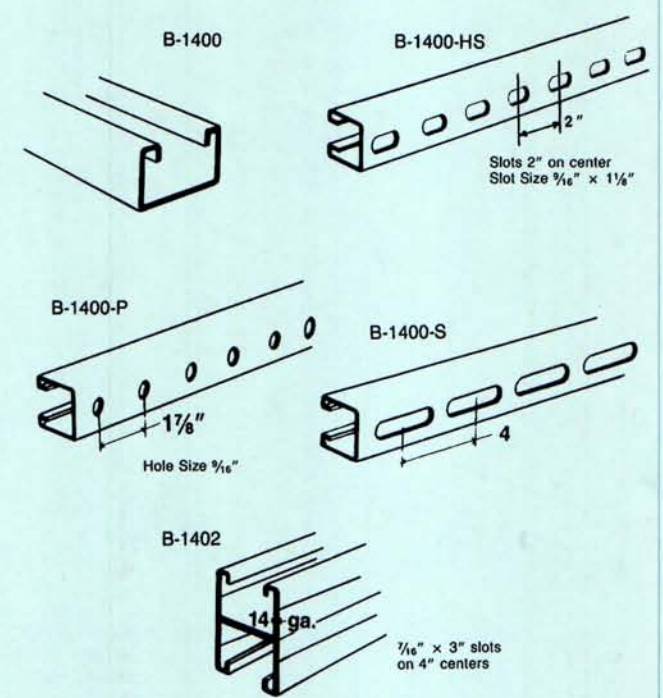

B-1400	97	500	6	\$ 194.75	\$ 199.35	\$ 199.35	\$ 326.50
B-1400-HS	87	500	6	220.50	225.15	225.15	342.40
B-1400-P	87	500	6	241.90	247.85	247.85	363.15
B-1400-S	85	500	6	247.60	270.70	270.70	371.70
B-1402	194	250	7	508.55	†	513.20	737.05

CUT CHANNEL POLICY

- A** – Minimum order – 25 cuts
- B** – Cost per cut 50¢ net
- C** – Customer must purchase Full Lengths
- D** – Drops will be shipped with order per customer's request

Note: All cuts after plating

*Available in 10' and 20' lengths
†Contact Factory

Catalog Number	Size	Wt./100	Pcs./Carton	Eng. Cat. Page	Price Per 100 EC
----------------	------	---------	-------------	----------------	------------------

NUTS AND BOLTS

A-100	¼	7	100	9	\$ 79.85
Spring	5/16	6	50	9	93.95
Nut	¾	10	100	9	85.15
	½	12	100	9	92.85
	5/8	19	50	9	174.30
	¾	19	50	9	192.75
	7/8	19	50	9	346.95



For A and C Channel

AB-100	¼	6	100	9	\$ 67.50
Springless	5/16	6	50	9	77.75
Nut	¾	9	100	9	68.85
	½	9	100	9	73.65
	5/8	10	50	9	140.25
	¾	10	50	9	147.75



Fits All Channels

AC-100	¼	6	50	9	\$ 71.50
Springless	5/16	8	100	9	73.40
Nut	½	11	50	9	79.30
	5/8	18	50	9	133.55
	¾	18	50	9	147.75



Fits All Channels Except B Channel

B-100	¼	6	100	9	\$ 85.70
Short Spring	5/16	8	50	9	94.90
Nut for "B"	¾	9	100	9	86.10
Series Channel	½	8	100	9	92.75



CM-100	¼	7	100	9	\$ 81.75
Channel	5/16	10	100	9	87.65
Master Nut	½	12	100	9	94.85



CM-100-B	½	7	100	9	\$ 94.65
½" Nut for "B" Channel					



Catalog Number	Size	Wt./100	Pcs./Carton	Eng. Cat. Page	Price Per 100 EC
----------------	------	---------	-------------	----------------	------------------

H-100	¾	10	50	9	\$ 118.30
Long Spring Nut	½	14	50	9	126.00
	5/8	20	50	9	†



Long Spring Nut for "E" & "H" Series Channel

AB-102	¼	13	100	24	\$ 91.80
	5/16	14	100	24	10.00
	½	14	100	24	103.20
	5/8	12	50	24	109.75
	¾	11	50	24	118.30
	7/8	10	50	24	130.65



Unhardened Square Nut

Catalog Number	Threads Per Size	Wt./100 Ft.	Ft. Bundle		Price Per 100 Ft	
			6'	10' 12'	Goldguard EC	Black Oiled

H-104	¼	20	12	300	500	180	\$ 27.40	\$ 23.40
Threaded Rod	5/16	16	29	150	250	180	42.35	34.40
	½	13	54	60	100	60	77.85	68.65
	5/8	11	83	30	50	60	115.60	102.25
	¾	10	125	60	60	120	204.10	161.80
	7/8	9	165	30	50	60	642.60	633.85
	1	8	225	30	50	60	997.25	†



NOTE: For Special Lengths—Finishes—Metals—Consult Factory
For BLACK—ADD SUFFIX B TO CATALOG NUMBER.
Example: H-104—½ x 10"—B

Catalog Number	Size	Wt./100	Pcs./Carton	Eng. Cat. Page	Price Per 100 EC
----------------	------	---------	-------------	----------------	------------------

NUTS & BOLTS (continued)

	H-119	1/4	6	50	11	\$ 87.35
	Standard	5/16	18	50	11	138.40
	Coupling	3/8	11	50	11	140.65
		1/2	11	50	11	179.10
		5/8	18	50	11	286.05
		3/4	30	50	11	416.55
		1	96	50	11	853.95
		94	50	11	1101.15	

	H-119	1/4 X 3/8	4	50	11	\$ 149.65
	Reducer	3/8 X 1/2	6	50	11	205.25
	Coupling	1/2 X 3/4	12	50	11	295.55
		3/4 X 1	21	50	11	432.40
		1 X 1 1/4	75	50	11	547.40

	E-120	3/8	15	25	10	\$ 514.75
		1/2	29	25	10	561.60

	E-122	3/8	30	25	10	\$ 933.75
		1/2	58	10	10	1212.40

	E-130	3/8	20	25	10	\$ 547.40
		1/2	38	25	10	601.95

	E-131	3/8	35	25	10	\$ 1043.30
		1/2	67	10	10	1157.25

Catalog Number	Size	Wt./100	Pcs./Carton	Eng. Cat. Page	Price Per 100 EC
----------------	------	---------	-------------	----------------	------------------

	E-142	1/4 X 1	2	100	10	\$ 13.95
		1/4 X 1 1/4	2	50	10	18.75
		1/4 X 1 1/2	2	50	10	20.20
		1/4 X 1 3/4	3	50	10	37.25
		1/4 X 2	4	50	10	51.45
		1/4 X 2 1/4	4	50	10	57.40
		1/4 X 2 1/2	5	50	10	63.75
		3/8 X 3/4	4	50	10	21.80
		3/8 X 1	4	50	10	23.20
		3/8 X 1 1/4	5	50	10	28.05
		3/8 X 1 1/2	6	50	10	31.15
		3/8 X 2	6	50	10	43.55
		1/2 X 1 3/8	9	50	10	44.75
		1/2 X 1 1/4	9	50	10	49.75
		1/2 X 1 1/2	10	50	10	56.15
	1/2 X 2	13	50	10	71.50	
	1/2 X 2 1/2	15	50	10	82.50	

	ES-142	1/2 X 1 1/2	21	50	9	\$ 314.10
					& 46	

	E-145	1/4	1	100	9	\$ 6.15
		3/8	2	100	9	10.15
		1/2	4	100	9	23.30
		3/4	7	50	9	38.85
		3/4	12	100	9	77.75
		7/8	19	50	9	104.20
		1	28	50	9	179.90

	EN-145	1/4	1	100		\$ 9.40
	Nylon Nuts	3/8	2	1		12.40

	ES-145	3/8	6	50	9	\$ 171.35
		1/2	6	50	9	181.00

	E-146	1/4	1	100	9	\$ 7.60
		3/8	2	100	9	9.40
		3/8	3	100	9	13.95
		1/2	6	100	9	37.25
		3/4	11	50	9	97.40

	E-147	1/4	1	100	9	\$ 5.70
		3/8	1	100	9	8.95
		3/8	2	100	9	9.10
		1/2	5	100	9	13.95
		5/8	8	50	9	31.15
		3/4	10	50	9	45.10
		7/8	15	50	9	49.75

Catalog Number	Size	Wt./100	Pcs./Carton	Eng. Cat. Page	Price Per 100 EC
----------------	------	---------	-------------	----------------	------------------

NUTS & BOLTS (continued)

EF-147	¼	3	100	9	\$ 23.65
Fender	¾	3	100	9	23.60
Washer	½	5	100	9	32.35



E-148	¼	1	100	9	\$ 3.20
	⅝	1	100	9	4.75
	¾	1	100	9	7.75
	½	1	100	9	13.95
	⅝	2	100	9	31.15



E-149	¼ X ¾	1	50	10	\$ 9.40
	¼ X 1	2	50	10	10.80
	¾ X 1¼	3	50	10	23.40
	¾ X 1¼	5	50	10	29.65



E-150-S	¾ X 1½	5	50	10	\$ 65.95
Lag Bolt	¾ X 2	7	50	10	80.70
	¾ X 2½	8	50	10	91.80
	¾ X 3	9	50	10	111.45
	½ X 1½	12	50	10	69.65
	½ X 2	13	50	10	117.30
	½ X 2½	16	50	10	141.25
	½ X 3	18	50	10	164.90



A-177	¼ X 1	10	50	9	\$ 289.20
Stud Nut w/o Spring	¼ X 1 ¼	10	50	9	290.80



A-179	¾ X 1	14	50	9	\$ 373.40
Stud Nut w/o Spring	¾ X 1¼	15	50	9	370.80



A-180	½ X 1	16	50	9	\$ 443.65
Stud Nut w/o Spring	½ X 1¼	17	50	9	455.70



Catalog Number	Size	Wt./100	Pcs./Carton	Eng. Cat. Page	Price Per 100 EC
----------------	------	---------	-------------	----------------	------------------

A-182	¼ X 1	9	50	9	\$ 328.15
Stud Nut with Spring	¼ X 1¼	10	50	9	331.35



A-184	¾ X 1	14	50	9	\$ 412.25
Stud Nut with Spring	¾ X 1¼	14	50	9	416.80



A-185	½ X 1	15	50	9	\$ 486.90
Stud Nut with Spring	½ X 1¼	16	50	9	494.65



†Contact Factory

Discount Schedule B

Catalog Number	Size	Wt./100	Pcs./Carton	Eng. Cat. Page	Price Per 100	
					EC	HDG

Catalog Number	Size	Wt./100	Pcs./Carton	Eng. Cat. Page	Price Per 100	
					EC	HDG

BRACKETS AND CHANNEL CONNECTORS

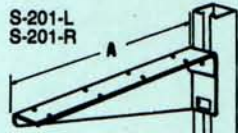
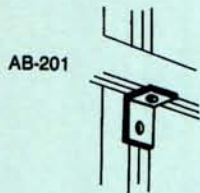

R as shown
L opposite hand

AB-201		35	50	13	\$ 121.65	\$ 188.95
S-201 L or R	6"	67	1	20	436.95	—
	8"	92	1	20	523.05	—
	10"	120	1	20	613.40	—
	12"	152	1	20	761.90	—
	14"	173	5	20	857.05	—
	16"	223	1	20	1017.15	—
	18"	266	1	20	1186.80	—
	20"	308	1	20	1365.70	—

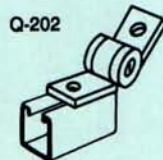

X-201		65	25	14	\$ 432.40	—
AB-202		35	50	13	121.65	188.95
Q-202	Hinge	68	20	19	889.65	—

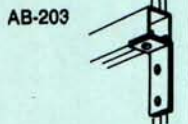

AB-203		58	50	13	\$ 173.00	\$ 259.75
AB-204		58	50	13	175.80	263.85

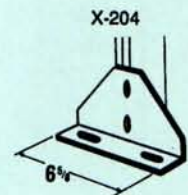

AW-204		76	25	17	\$ 444.80	—
S-204		174	1	20	1111.95	—
X-204		190	25	14	1016.15	—

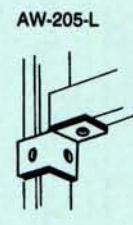
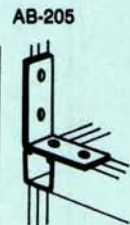

AB-205		78	25	13	\$ 340.25	†
AW-205-R		59	25	17	544.40	—
AW-205-L		59	25	17	544.40	—

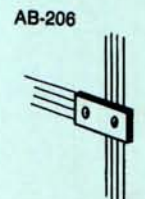
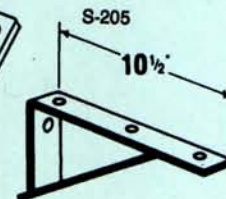

Q-205	Hinge	109	25	19	\$ 1900.65	—
S-205		264	1	20	1421.50	—
AB-206		35	50	15	127.75	185.20

Catalog Number	Size	Wt./100	Pcs./Carton	Eng. Cat. Page	Price Per 100	
					EC	HDG

BRACKETS AND CHANNEL CONNECTORS (continued)

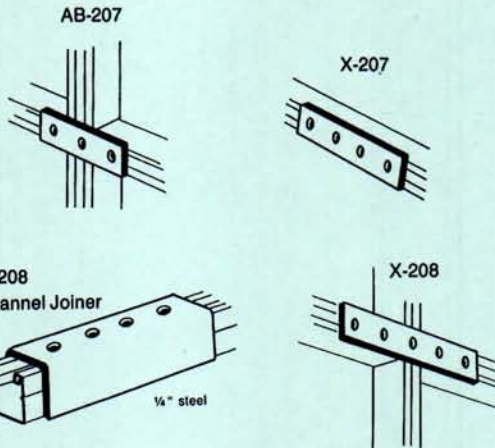

AB-207	56	50	15	\$ 175.70	—
X-207	78	50	15	247.40	—
A-208	257	20	15	919.90	—
X-208	88	25	15	365.55	—

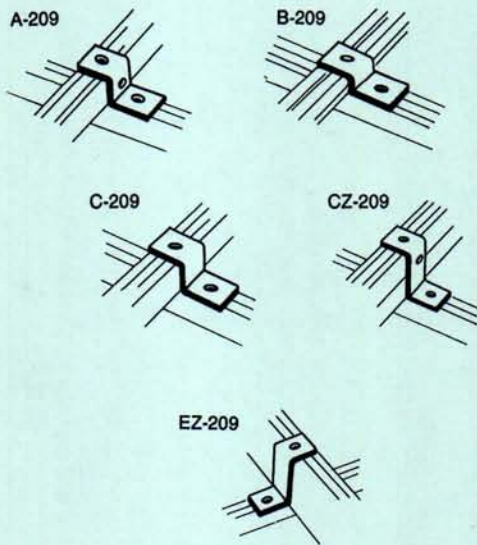

A-209	55	25	16	\$ 290.55	\$ 421.05
B-209	43	25	16	225.45	—
C-209	49	25	16	241.05	—
CZ-209	70	25	16	348.40	—
EZ-209	67	25	16	376.35	—

Catalog Number	Size	Wt./100	Pcs./Carton	Eng. Cat. Page	Price Per 100	
					EC	HDG

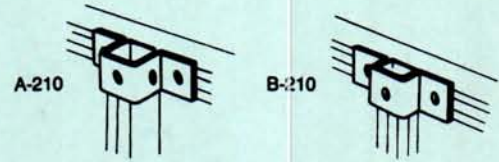

A-210	88	25	18	\$ 273.10	—
B-210	65	25	18	340.65	—

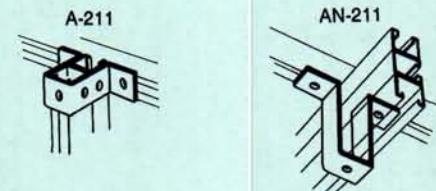

C-210	77	10	18	\$ 457.15	—
E-210	112	10	18	622.30	—
A-211	128	10	18	656.35	—
AN-211	181	10	18	872.60	—

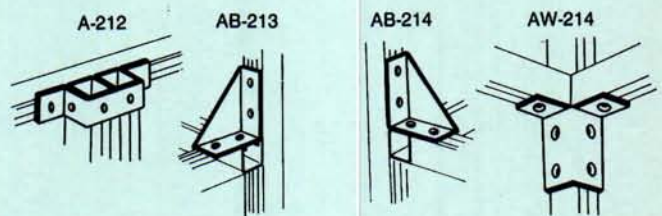

A-212	113	10	18	\$ 711.60	†
AB-213	125	10	15	610.20	†
AB-214	125	10	13	633.20	†
AW-214	115	10	17	580.10	†

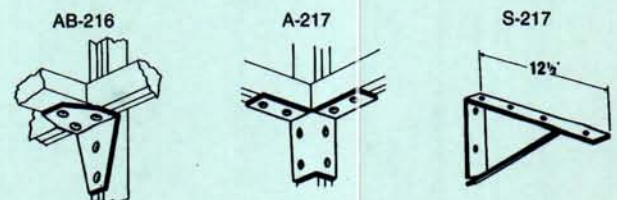

AB-216	135	10	13	\$ 788.55	—
A-217	155	10	17	810.45	—
S-217	264	1	20	1762.25	—

†Contact Factory

Discount Schedule B

Thomas & Betts

Catalog Number	Size	Wt./100	Pcs./Carton	Eng. Cat. Page	Price Per 100 EC
----------------	------	---------	-------------	----------------	------------------

BRACKETS AND CHANNEL CONNECTORS (continued)

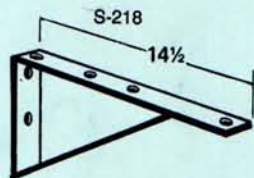
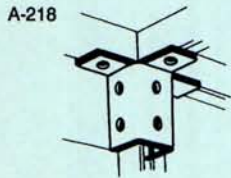

A-218	177	10	17	\$ 887.75	—
S-218	295	1	20	1983.15	—

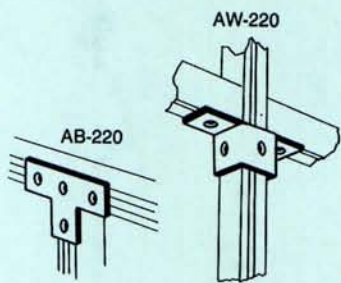
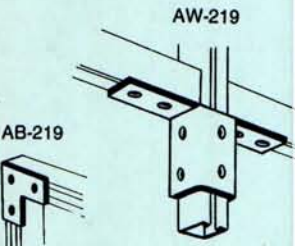

AB-219	58	25	15	\$ 252.75	—
AW-219	187	10	17	1300.45	—
AB-220	78	25	15	338.55	—
AW-220	90	20	17	720.20	—

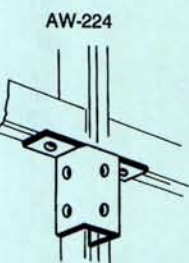
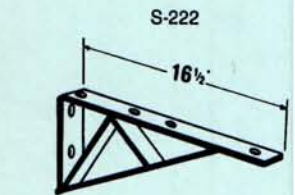

S-222	385	1	21	\$ 2541.45	—
AW-224	147	10	17	920.90	—
AB-225	58	25	16	273.95	—

Catalog Number	Size	Wt./100	Pcs./Carton	Eng. Cat. Page	Price Per 100 EC
----------------	------	---------	-------------	----------------	------------------

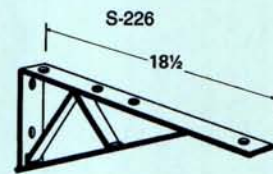
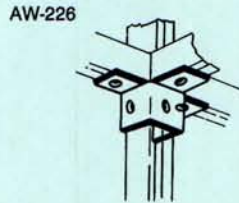

AB-227

AW-228

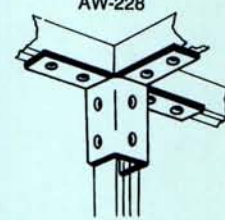
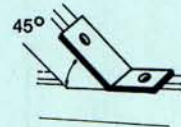

AP-232

AP-235

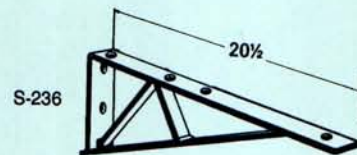
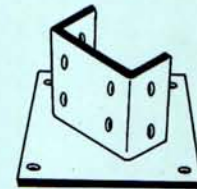
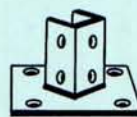

AW-226	113	20	17	\$ 709.30	—
S-226	421	1	21	3288.15	—
AB-227	58	50	16	271.15	—
AW-228	230	10	17	1241.15	—
AP-232	384	10	19	1964.80	—
AP-235	400	1	19	2405.45	—
S-236	744	1	21	4007.70	—

†Contact Factory

Catalog Number	Size	Wt./100	Pcs./Carton	Eng. Cat. Page	Price Per 100	
					EC	HDG

BRACKETS AND CHANNEL CONNECTORS (continued)

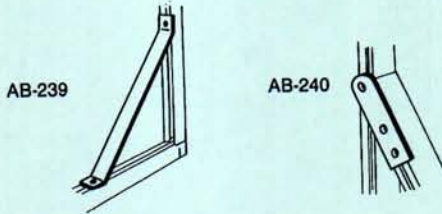

AB-239-1	148	15	16	\$ 427.70	—
AB-239-2	240	10	16	893.85	—
AB-239-3	363	10	16	1037.30	—
AB-240	69	1	16	547.40	—

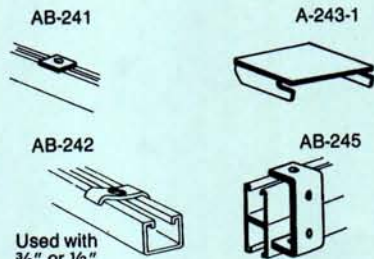

AB-241	¼	18	100	15	\$ 71.50	—
AB-241	⅜	18	100	15	73.05	—
AB-241	½	18	100	15	73.95	107.15
AB-241	¾	17	100	15	75.55	109.45
AB-241	1	15	100	15	77.75	—
AB-241	1 ¼	14	50	15	101.00	—
AB-242		17	50	15	88.55	—
A-243-1		16	50	51	163.75	—
AB-245		70	10	18	368.55	—

Used with
⅜" or ½"
hardware

Catalog Number	Size	Wt./100	Pcs./Carton	Eng. Cat. Page	Price Per 100	
					EC	HDG

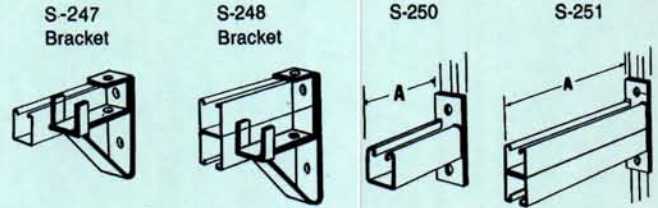

S-247		229	1	21	\$ 1699.75	—
S-248		272	1	21	1913.90	—
S-250-6	6"	150	1	21	1336.05	—
S-250-12	12"	250	1	21	1352.85	—
S-250-18	18"	350	1	21	1493.65	—
S-250-24	24"	450	1	21	1710.45	—
S-251-12	12"	514	1	21	3033.15	—
S-251-18	18"	714	1	21	3320.80	—
S-251-24	24"	914	1	21	3914.90	—
S-251-30	30"	1114	1	21	4444.00	—
S-251-36	36"	1314	1	21	4722.30	—

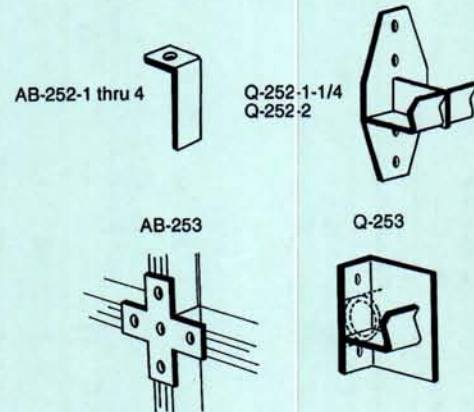

AB-252-1		61	50	13	\$ 276.95	—
AB-252-2		84	10	13	307.95	—
AB-252-3		84	10	13	339.10	—
AB-252-4		130	10	13	370.20	—
Q-252-1-1/4		305	10	19	3088.40	—
Q-252-2		405	10	19	2513.40	—
AB-253		97	25	15	676.70	—
Q-253		205	10	19	3088.40	—

Catalog Number	Size	Wt./100	Pcs./Carton	Eng. Cat. Page	Price Per 100 EC
----------------	------	---------	-------------	----------------	------------------

Catalog Number	Size	Wt./100	Pcs./Carton	Eng. Cat. Page	Price Per 100 EC
----------------	------	---------	-------------	----------------	------------------

BRACKETS AND CHANNEL CONNECTORS
(continued)

AB-254-L

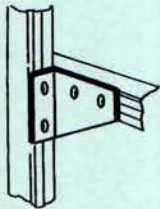

AB-254-R

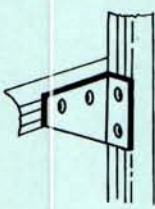

Q-254



AB-255

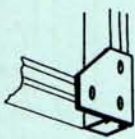

Q-255

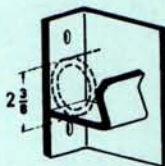

AB-254-L	105	10	13	\$ 542.75	—
AB-254-R	105	10	13	542.75	—
Q-254	205	10	19	3088.40	—
AB-255	70	10	15	365.55	—
Q-255	234	10	19	1315.80	—

Q-256

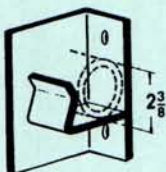

S-256

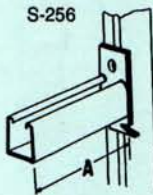

When Installed In Inverted Position Reduce Load Rating 40%

Q-256	234	10	19	\$ 1315.80	—	
S-256-6	6"	151	1	21	1131.00	—
S-256-12	12"	251	1	21	1353.95	—
S-256-18	18"	351	1	21	1488.60	—
S-256-24	24"	451	1	21	3091.90	—

AB-257

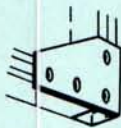

AB-260-R

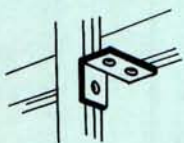

AB-260-L

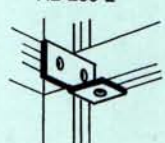

AB-257	105	25	15	\$ 474.45	—
AB-260-R	58	25	13	336.05	—
AB-260-L	58	25	13	336.05	—

AB-261

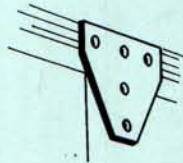

AB-263

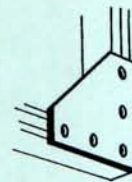

AB-265

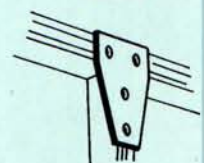

AB-261	148	10	15	\$ 802.70	—
AB-263	150	10	15	698.40	—
AB-265	105	10	15	581.70	—

AN-270

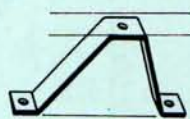

TS-272

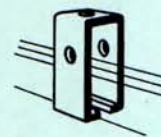

TS-273

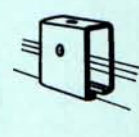

AB-274



AN-270-1	113	10	20	\$ 556.90	—
AN-270-2	151	10	20	769.80	—
AN-270-3	199	10	20	995.45	—
AN-270-4	246	10	20	1070.10	—
AN-270-5	293	10	20	1222.60	—
TS-272	104	10	20	690.65	—
TS-273	228	10	20	1038.95	—
AB-274	70	25	13	448.40	—

†Contact Factory

Discount Schedule B

Catalog Number	Size	Wt./100	Pcs./Carton	Eng. Cat. Page	Price Per 100 EC
----------------	------	---------	-------------	----------------	------------------

BRACKETS AND CHANNEL CONNECTORS (continued)

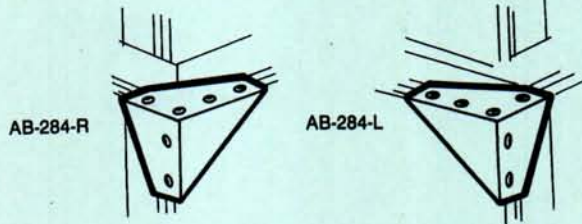

AB-284-R	230	1	13	\$ 1647.15	—
AB-284-L	230	1	14	1647.15	—

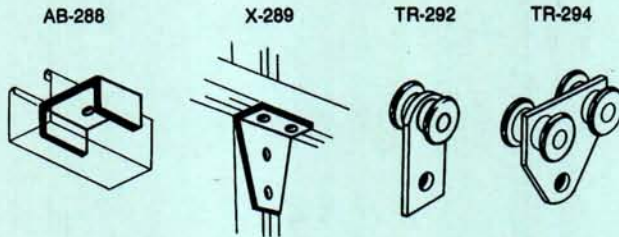

AB-288-3/8	3/8	37	50	18	\$ 203.90	—
AB-288-1/2	1/2	37	50	18	216.15	—
AB-288-5/8	5/8	37	50	18	216.15	—
X-289		105	25	14	609.75	—
TR-292		59	20	19	1918.40	—
TR-294		106	10	19	3590.45	—

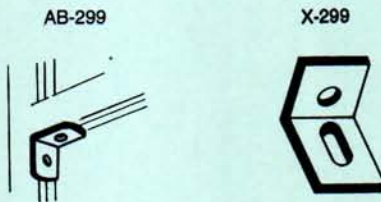

AB-299	40	50	14	\$ 187.95	—
X-299	38	25	14	261.25	—

Catalog Number	Size	Wt./100	Pcs./Carton	Eng. Cat. Page	Price Per 100 EC
----------------	------	---------	-------------	----------------	------------------

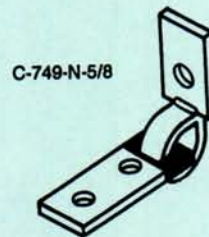

C-749-N	1/2	61	50	46	\$ 1321.10	—
C-749-N-5/8	5/8	67	25	46	1518.05	—
C-749-N-7/8	7/8	74	25	46	1518.05	—
C-749-N-1-1/8	1-1/8	72	25	46	†	—

†Contact Factory

Catalog Number	Size	Wt./100	Pcs./Carton	Eng. Cat. Page	Price Per 100 EC
----------------	------	---------	-------------	----------------	------------------

INSERTS

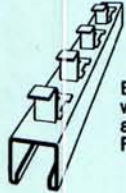

B-302
w/End Caps
and Foam
Filler.

B-302	10'	139	1	23	\$ 486.90
	20'	139	1	23	

Consult Factory for other lengths.

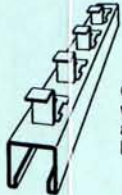

C-302
w/End Caps
and Foam
Filler.

C-302	10'	195	360	23	\$ 488.00
	20'	195	720	23	

Consult Factory for other lengths.

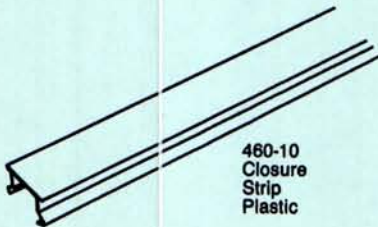

460-10
Closure
Strip
Plastic

460-10	10'	4	500	24	\$ 49.55
--------	-----	---	-----	----	----------

Catalog Number	Size	Wt./100	Pcs./Carton	Eng. Cat. Page	Price Per 100 EC
----------------	------	---------	-------------	----------------	------------------

450
End Cap



452



C-450		30	50	23	\$ 146.95
452		52	50	24	132.65

Catalog Number	Size	Wt./100	Pcs./Carton	Eng. Cat. Page	Price Per 100	
					EC	HDG

BEAM CLAMPS

U-501, U-502

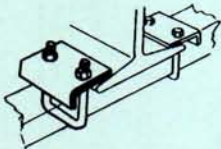

U-504



U-505



U-510

1/2 x 1 1/2
Set Screw
Included



512



U-501		90	20	30	\$ 344.05	\$ 453.10
U-502		100	20	30	431.35	†
U-504	(single type)	140	25	30	735.65	—
U-505	(pair type)	270	1	30	1594.20	—
U-510		75	25	30	685.80	—
512		26	50	30	183.20	—

U-514



3/8 x 1 1/2 Set Screw
Included

U-515



2 Holes
5/16" Die
1/2 x 1 1/2
Included

U-514-A

1/2 x 1 1/2
Set Screw
Included



U-515-B



U-520, U-521, & U-522

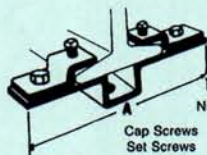

Nut Included

Cap Screws
Set Screws
Included

U-514		39	50	30	\$414.75	\$ 601.05
U-514A		59	50	30	471.35	683.15
U-515		95	25	30	598.85	962.75
U-515B	For B Channel	95	25	30	664.30	—
U-520		328	10	31	2222.60	—
U-521		343	10	31	†	—
U-522		353	10	31	2342.40	—

Catalog Number	Size	Wt./100	Pcs./Carton	Eng. Cat. Page	Price Per 100	
					EC	B

540



S-541
Swing Connector



3/4 x 1 3/4
Nut & Bolt
Included

540	3/8	40	25	31	\$ 107.90	\$ 107.60
	1/2	36	25	31	187.60	185.10
	5/8	84	25	31	223.95	202.15
	3/4	113	25	31	287.70	256.60
S-541	7/8	106	25	31	435.65	396.60
	3/8	31	25	31	342.25	—

U-560



Beam Clamp
Heavy Duty

U-562



Square Nut
Order Separately

1/2 Set Screw
Nut Included

Beam Clamp
Optional Use

US-562

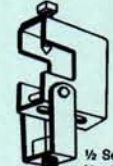

1/2 Set Screw
Nut Included

Beam Clamp
with
Swing Hanger

U-560	1/4	67	25	31	\$ 715.55	—
	3/8	67	25	31	723.30	—
	1/2	130	25	31	995.45	—
	5/8	130	25	31	1180.25	—
U-562		80	25	32	471.90	683.85
US-562		113	50	32	484.45	—

Catalog Number	Size	Wt./100	Pcs./Carton	Eng. Cat. Page	Price Per 100 EC
----------------	------	---------	-------------	----------------	------------------

BEAM CLAMPS (continued)

U-563 Beam Clamp



¼ Set Screw and Nut Included

US-563 Beam Clamp with Swing Hanger



¼ Set Screw Included

Beam Clamp Optional Use

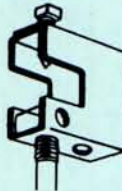

¼ Set Screw Included
Square Nut Order Separately

U-563	33	25	32	\$ 288.80	—
US-563	50	25	32	520.90	—

U-564 Beam Clamp Heavy Duty



U-568



Beam Clamp Safety Strap

U-569 Beam Clamp with Safety Rod

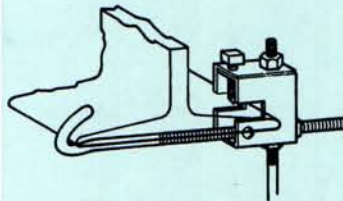

A-570 Beam Clamp with Safety Rods

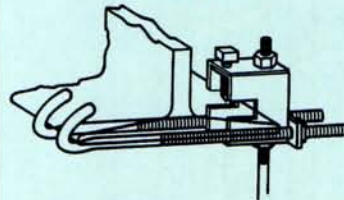

U-564	¾	109	25	32	\$ 1180.20	—
	½	201	15	32	1633.15	—
	¾	201	15	32	1633.15	—
U-568-1		18	25	33	193.55	—
U-568-2		25	25	33	226.50	—
U-568-3		24	25	33	191.95	—
U-568-4		33	25	33	221.00	—
U-568-5		42	25	33	231.15	—
U-568-6		26	25	33	186.60	—
U-568-7		35	25	33	210.10	—
U-568-8		44	25	33	221.80	—
U-569		150	25	33	970.80	—
A-570	½	220	1	33	1117.30	—

Catalog Number	Size	Wt./100	Pcs./Carton	Eng. Cat. Page	Price Per 100 EC	HGD
----------------	------	---------	-------------	----------------	------------------	-----

U-571

U-572



U-571	39	25	36	\$ 164.20	—
U-572	40	25	36	337.25	—

U-576



U-577 Clevis and Swing Connector

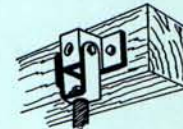

U-579



Nuts & Wood Screws Not Included

A-597

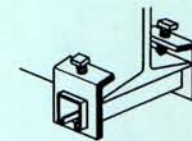

U-576	¾	36	25	33	\$ 552.15	—
	½	36	25	33	552.15	—
U-577		69	25	33	933.30	—
U-579	¾	30	25	33	162.75	—
	½	50	25	33	217.75	—
A-597		108	25	31	513.85	744.75

Catalog Number	Size	Wt./ 100	Pcs./ Carton	Eng. Cat. Page	Price Per 100	
					EC	B

BEAM CLAMPS (continued)

M-775-L w/Locknut	3/8	42	25	34	216.95	\$ 131.95
	1/2	49	25	34	273.05	166.95
	5/8				—	256.15
	3/4				—	347.70



WW-H-171E
Type 23

C-775-L w/Locknut	3/8	33	50	34	\$ 309.15	\$ 190.35
	1/2	41	50	34	365.10	248.65
	5/8	67	50	34	552.05	480.00
	3/4	71	50	34	757.70	651.45
	7/8	163	50	34	1306.35	1151.95



WW-H-171E
Type 23

M-777 Top Beam Clamp	3/8	30	25	34	\$ 130.25	\$ 102.95
	1/2	36	25	34	176.60	137.15



M-778 Wide Top Beam Clamp	3/8	44	25	35	\$ 195.55	\$ 140.65
	1/2	36	25	35	246.95	193.75
	5/8	45	25	35	425.20	361.80
	3/4	67	25	35	—	461.15



C-781 Steel Washer Plate	3/8	62	25	35	\$ 780.45	—
	1/2	62	25	35	780.45	—
	5/8	91	25	35	1124.30	—
	3/4	164	25	35	1124.30	—

†Contact Factory

Discount Schedule B

Catalog Number	Size	Wt./100	Pcs./Carton	Eng. Cat. Page	Price Per 100 EC
----------------	------	---------	-------------	----------------	------------------

PIPE CLAMPS AND HANGERS

700 Thin Wall Conduit Clamp

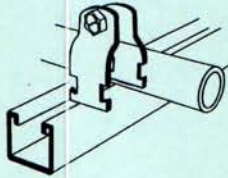

700 Thin Wall Conduit Clamp	3/8	12	100	26	\$ 79.90	—
	1/2	12	100	26	82.65	—
	3/4	13	100	26	93.65	—
	1	16	100	26	99.10	—
	1 1/4	19	50	26	115.60	—
	1 1/2	29	50	26	130.90	—
	2	33	50	26	148.85	—

701 OD Tubing Pipe Clamp

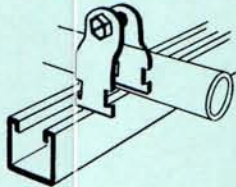

701 OD Tubing Pipe Clamp	1/4	8	100	26	\$ 107.05	—
	3/8	8	100	26	110.00	—
	1/2	9	100	26	104.65	—
	5/8	10	100	26	106.10	—
	3/4	11	100	26	117.40	—
	7/8	12	100	26	115.60	—
	1	14	50	26	144.80	—
	1 1/8	15	100	26	130.90	—
	1 1/4	16	25	26	150.90	—
	1 3/8	17	100	26	137.85	—
	1 1/2	18	25	26	158.75	—
	1 5/8	19	100	26	143.25	—
	1 3/4	28	25	26	186.60	—
	1 7/8	29	50	26	210.10	—
	2	31	50	26	216.15	—
	2 1/8	32	50	26	222.50	—
	2 1/4	33	25	26	228.65	—
	2 3/8	34	25	26	233.40	—
	2 1/2	35	25	26	237.95	—
	2 5/8	37	50	26	219.10	—
	2 3/4	38	50	26	250.45	—
	2 7/8	40	25	26	256.60	—
	3	41	25	26	264.40	—
	3 1/8	43	25	26	239.75	—
	3 1/4	45	25	26	273.95	—
	3 3/8	46	25	26	281.60	—
	3 1/2	47	25	26	289.20	—
	3 5/8	56	25	26	280.15	—
	3 3/4	58	25	26	307.95	—
	3 7/8	60	25	26	365.55	—
	4	62	25	26	371.80	—
	4 1/8	62	25	26	370.95	—
	4 1/4	64	25	26	388.75	—
	4 3/8	66	25	26	356.85	—
	4 1/2	67	10	26	415.45	—
	4 5/8	70	10	26	419.10	—
	4 3/4	72	10	26	421.50	—

Catalog Number	Size	Wt./100	Pcs./Carton	Eng. Cat. Page	Price Per 100 EC
----------------	------	---------	-------------	----------------	------------------

701 (cont.)	4 7/8	70	10	26	\$ 429.30	—
OD Tubing Pipe Clamp	5	74	10	26	440.10	—
	5 1/8	76	10	26	449.45	—
	5 1/4	77	10	26	458.85	—
	5 3/8	78	10	26	466.60	—
	5 1/2	79	10	26	482.15	—
	5 5/8	88	10	26	517.85	—
	5 3/4	90	10	26	531.90	—
	5 7/8	92	10	26	542.75	—
	6	94	10	26	552.15	—
	6 1/8	96	10	26	590.20	—
	6 1/4	98	10	26	626.35	—
	6 3/8	99	10	26	635.00	—
	6 1/2	100	10	26	639.45	—
	6 5/8	102	10	26	645.70	—
	6 3/4	104	10	26	649.00	—
	6 7/8	106	10	26	650.45	—
	7	108	10	26	651.35	—
	7 1/8	110	10	26	653.30	—
	7 1/4	112	10	26	661.00	—
	7 3/8	114	10	26	675.00	—
	7 1/2	116	10	26	681.25	—
	7 5/8	117	10	26	690.65	—
	7 3/4	119	10	26	698.40	—
	7 7/8	121	10	26	710.90	—
	8	123	10	26	718.55	—
	8 1/8	125	10	26	726.25	—
	8 1/4	126	10	26	735.65	—
	8 3/8	128	10	26	746.60	—
	8 1/2	129	10	26	757.40	—
	8 5/8	130	10	26	769.80	—
	12	300	1	26	1004.10	—

CT-701 Copper Plated	3/8	8	100	26	\$ 150.90	—
	1/2	9	100	26	147.75	—
	5/8	10	100	26	132.40	—
	3/4	11	100	26	174.00	—
	7/8	12	100	26	142.00	—
	1 1/8	15	100	26	171.55	—
	1 3/8	17	100	26	180.25	—
	1 1/2	19	100	26	188.80	—
	2 1/8	32	50	26	257.05	—
	2 3/8	37	50	62	303.20	—
	3 1/8	43	50	26	334.45	—
	3 3/8	56	50	26	373.40	—
	4 1/8	62	25	26	458.85	—

†Contact Factory

Catalog Number	Size	Wt./100	Pcs./Carton	Eng. Cat. Page	Price Per 100	
					EC	HDG

PIPE CLAMPS AND HANGERS (continued)

702	¾	10	100	27	\$ 90.20	—
Pipe and	½	11	100	27	82.65	128.60
Rigid	¾	14	100	27	93.65	137.65
Conduit	1	17	100	27	99.10	156.10
Clamp	1¼	18	50	27	115.60	179.90
	1½	29	50	27	130.90	205.60
	2	24	50	27	148.85	233.25
	2½	40	50	27	174.55	269.90
	3	47	50	27	190.60	295.35
	3½	62	25	27	224.40	348.10
	4	67	25	27	249.30	387.25
	5	80	25	27	332.85	—
	6	102	10	27	444.80	—
	8	130	10	27	581.70	—
	10	160	10	27	965.65	—
	12	190	10	27	943.85	—

Discount Schedule C

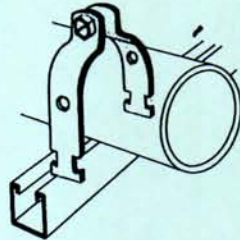

703	½	15	100	27	\$ 82.65	—
Universal	¾	16	100	27	93.65	—
Clamp	1	18	100	27	99.10	—
	1¼	22	50	27	115.60	—
	1½	29	50	27	130.90	—
	2	34	50	27	148.85	—

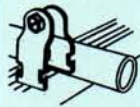

Discount Schedule C

C-708U	½	23	50	29	\$ 262.75	†
	¾	26	50	29	278.50	†
	1	31	50	29	293.95	†
	1¼	35	25	29	304.80	†
	1½	39	25	29	314.75	†
	2	94	25	29	563.50	†
	2½	114	25	29	602.15	†
	3	133	25	29	662.15	†
	3½	152	25	29	704.40	†
	4	176	25	29	748.30	†
	5	198	10	29	838.20	—
	6	246	10	29	1028.20	†



This Strap is Designed for Use with Channel

Discount Schedule B

Catalog Number	Wt./100	Pcs./Carton	Eng. Cat. Page	Price Per 100
----------------	---------	-------------	----------------	---------------

S-716	260	20	29	\$ 6381.25	—
--------------	-----	----	----	------------	---

Cush-A-Strip



Priced per 100 Cartons (20' per Carton)

Discount Schedule F

Catalog Number	Copper & Steel Tubing O.D.	Copper Water Pipe (Nom.)	Wt./100	Pcs./Carton	Eng. Cat. Page	Price Per 100	
						EC	HDG

A-716	¼		10	25	28	\$ 325.85	—
Cush-A-Clamp for Tubing	¾	¼	11	25	28	325.85	—
	½	¾	13	25	28	322.85	—
	¾	½	14	25	28	332.00	—
	¾	¾	14	25	28	386.40	—
	¾	¾	15	25	28	421.90	—
	1		17	10	28	491.55	—
	1¼	1	18	10	28	489.60	—
	1¼		18	10	28	577.60	—
	1½	1¼	20	10	28	579.35	—
	1½		33	10	28	725.85	—
	1½	1½	35	10	28	760.40	—
	1¾		37	10	28	997.05	—
	1¾		39	10	28	1170.80	—
	2		41	10	28	1344.50	—
	2½		46	10	28	1404.90	—
	2¾		47	10	28	1632.65	—
	2¾		51	10	28	1623.25	—
	3½		60	10	28	2119.90	—
	4½		94	10	28	4308.95	—



Discount Schedule F

Catalog Number	Size	Wt./100	Pcs./Carton	Eng. Cat. Page	Price Per 100
----------------	------	---------	-------------	----------------	---------------

P-716	¼	13.0	25	28	\$ 405.00	—
Cush-A-Clamp for Pipe	¾	14.0	25	28	423.70	—
	½	15.0	25	28	523.30	—
	¾	17.0	25	28	554.40	—
	1	19.0	20	28	735.15	—
	1¼	35.0	10	28	1059.15	—
	1½	39.0	10	28	1138.30	—
	2	47.0	10	28	1925.15	—
	2½	55.0	10	28	2548.30	—
	3	64.0	10	28	3725.85	—
	3½	88.0	bulk	28	5283.55	—
	4	110.0	bulk	28	6080.95	—

U-716	¼	3	25	28	318.35	—
Omega Clamp	¾	4	25	28	332.15	—
	½	6	25	28	332.15	—
	¾	6	25	28	332.15	—
	¾	7	25	28	338.85	—
	¾	7	25	28	352.90	—
	1	8	25	28	382.00	—
	1½	8	25	28	404.85	—
	1¼	17	10	28	507.40	—
	1¾	20	10	28	520.50	—
	1½	20	10	28	527.60	—
	1¾	23	10	28	542.05	—
	1¾	32	10	28	607.15	—
	1¾	34	10	28	628.95	—
	2	36	10	28	650.45	—
	2½	41	10	28	701.10	—
	2¾	46	10	28	0.00	—
U-717	¾	8	25	28	390.35	—
	1	20	10	28	513.30	—
	1¼	32	10	28	578.20	—

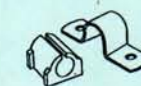

Discount Schedule F

†Contact Factory

Catalog Number	Size	Wt./100	Pcs./Carton	Eng. Cat. Page	Price Per 100 EC
----------------	------	---------	-------------	----------------	------------------

PIPE CLAMPS AND HANGERS (continued)

 <p>S-720 Seismic Hanger</p>	¾	136	10	46	\$ 1003.20	—
	1	138	10	46	1023.95	—
	1¼	195	10	46	1237.95	—
	1½	201	10	46	1266.50	—
	2	217	10	46	1066.90	—
	2½	229	10	46	1396.70	—
	3	250	10	46	1533.20	—
	3½	330	10	46	1964.80	—
	4	342	10	46	2047.30	—
	5	493	10	46	3031.35	—
	6	526	10	46	3444.10	—
	8	986	5	46	5672.30	—
10	1100	1	46	6268.95	—	
12	1660	1	46	9443.30	—	



PG-795	40**	25	45	\$ 261.25	—
--------	------	----	----	-----------	---

Catalog Number	Size	Wt./100	Pcs./Carton	Eng. Cat. Page	Price Per 100 EC
----------------	------	---------	-------------	----------------	------------------

ELECTRICAL FITTINGS

802
Joiner with Reinforcing Plate

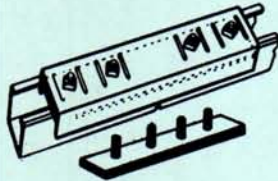

A-802		159	25	51	\$ 554.75
B-802		112	25	51	525.70
E-802		170	25	51	1444.55
H-802		182	25	51	1144.90
AB-803		63	25	52	1379.65
A-804		10	25	51	56.35
B-804		5	25	51	39.55
C-804		8	25	51	47.70

AB-803
Cast Conduit Connector

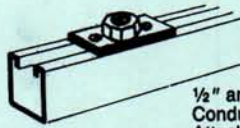

½" and ¾"
Conduit
Attachment
to Channel.

804 End Cap



805 End Cap
with Knockouts



KO for ½" conduit

E-804		20	25	51	\$ 144.80
H-804		19	25	51	152.15
A-805		20	25	51	270.70
C-805		20	25	51	270.70
E-805		30	25	51	297.85
H-805		31	25	51	307.95
A-809	¾	25	25	51	270.70
A-809	1	24	25	51	454.10

809 Tapped End Cap

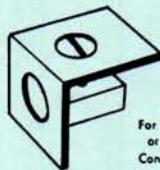

For ¾"
or 1"
Conduit

Catalog Number	Size	Wt./100	Pcs./Carton	Eng. Cat. Page	Price Per 100 EC
----------------	------	---------	-------------	----------------	------------------

811 Stud Nut

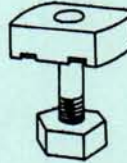

811-1	¼ X ¾	8	50	51	\$ 143.05
811-2	¼ X 1¼	9	50	51	143.05
AB-815		140	15	52	2279.80

AB-315 Swing Connector

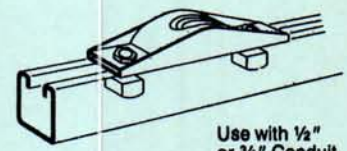

Use with ½"
or ¾" Conduit.

822 Channel Joiner & Seal

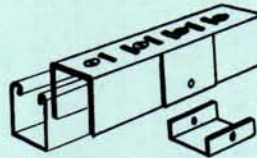

A-822		75	25	51	\$ 678.40
B-822		56	25	51	641.90
C-822		70	25	51	770.35
AB-844	Price/100'	41	500	53	114.90
AB-844-PC	Price/100' Plastic	12	500	53	114.90

AB-844 Steel or Plastic Closure Strip
10' Lengths

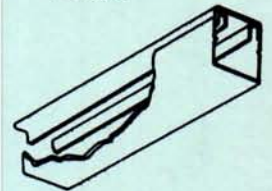

A-853



A-853		25	50	51	196.70
A-853-L		48	25	51	248.85
A-854		28	25	52	314.00
A-854-L		51	25	52	338.95

A-853-L

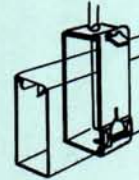

A-854

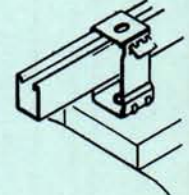

Catalog Number	Size	Wt./100	Pcs./Carton	Eng. Cat. Page	Price Per 100 EC
----------------	------	---------	-------------	----------------	------------------

Catalog Number	Size	Wt./100	Pcs./Carton	Eng. Cat. Page	Price Per 100 EC
----------------	------	---------	-------------	----------------	------------------

ELECTRICAL FITTINGS (continued)



AB-840-P
PORCELAIN
CABLE CLAMPS
 Includes Steel
 Clamp and Bronze
 Hardware

AB-840-P	3/8	54	10	54	\$ 1775.70
AB-841-P	1/2	53	10	54	1775.70
AB-842-P	5/8	51	10	54	1775.70
AB-843-P	3/4	94	10	54	1851.25
AB-844-P	7/8	89	10	54	\$ 1851.25
AB-845-P	1	84	10	54	1851.25
AB-846-P	1 1/8	81	10	54	1851.25
AB-847-P	1 1/4	122	10	54	1882.05
AB-848-P	1 3/8	119	10	54	1882.05
AB-849-P	1 1/2	114	10	54	1882.05
AB-850-P	1 5/8	111	10	54	1882.05
AB-851-P	1 3/4	238	10	54	1959.80
AB-852-P	1 7/8	232	10	54	1959.80
AB-853-P	2	221	10	54	1959.80
AB-854-P	2 1/8	217	10	54	1959.80
AB-855-P	2 1/4	274	10	54	2034.80
AB-856-P	2 3/8	267	10	54	2034.80
AB-857-P	2 1/2	259	10	54	2034.80
AB-858-P	2 5/8	252	10	54	2034.80
AB-859-P	2 3/4	347	10	54	2561.15
AB-860-P	2 7/8	336	10	54	2561.15
AB-861-P	3	325	10	54	2561.15
AB-862-P	3 1/8	314	10	54	2561.15
AB-863-P	3 1/4	495	10	54	3197.75
AB-864-P	3 3/8	480	10	54	3197.75
AB-865-P	3 1/2	465	10	54	3197.75
AB-866-P	3 5/8	450	5	54	3197.75
AB-867-P	3 3/4	712	5	54	3197.75
AB-868-P	3 7/8	696	5	54	3499.00
AB-869-P	4	683	5	54	3499.00
AB-870-P	4 1/8	670	5	54	3499.00
AB-871-P	4 1/4	645	5	54	3499.00
AB-872-P	4 3/8	632	5	54	3499.00
AB-873-P	4 1/2	617	5	54	3499.00

Specify exact hole size to fit your cable

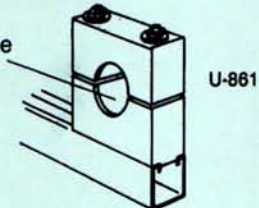

U-861-1	84	1	54	\$ 2328.15
U-861-2	102	1	54	3826.50
U-861-3	121	1	54	3973.75
U-861-4	165	1	54	4004.00
U-861-5	189	1	54	4354.10
U-861-6	215	1	54	4494.20
U-861-7	243	1	54	7281.25
U-861-8	270	1	54	9089.90

AB-866



AB-867



AB-868
 Fibre Wire
 Retainer



AB-866	6	100	53	\$ 254.10
AB-867	24	25	53	291.70
AB-868	3	100	53	46.60

AB-880
 3" Porcelain Saddle
AB-881
 4" Porcelain Saddle

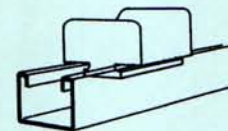

AB-880	82	10	54	\$ 544.45
AB-881	120	10	54	650.00

Catalog Number	Size	Wt./100	Pcs./Carton	Eng. Cat. Page	Price Per 100 EC
----------------	------	---------	-------------	----------------	------------------

ELECTRICAL FITTINGS (continued)

AB-885



AB-885	24	25	54		\$ 2478.15
--------	----	----	----	--	------------

AB-887

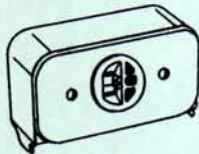

AB-888



AB-887	50	10	53		\$ 2284.90
AB-887-W/O	39	10	53		2246.80
AB-888-W/O	37	10	53		2250.45

Catalog Number	Size	Wt./100	Pcs./Carton	Eng. Cat. Page	Price Per 100 EC
----------------	------	---------	-------------	----------------	------------------

A-889



A-890

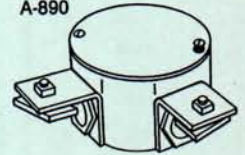

A-891

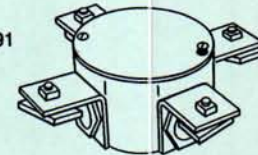

A-892

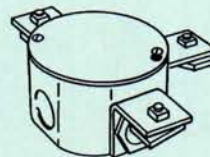

A-893

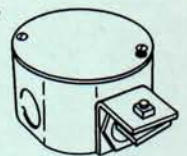

A-889	120	10	52		\$ 2042.25
A-890	120	10	52		2042.25
A-891	140	10	52		2578.85
A-892	130	10	52		2331.50
A-893	110	10	52		1693.85

Catalog Number	Length	Package	Fl. Pkg.	Wt. 100'	Eng. Cat. Page	Price per 100'
----------------	--------	---------	----------	----------	----------------	----------------

SUPERANGLE® SLOTTED ANGLE



Part Number	Length	Package	Fl. Pkg.	Wt. 100'	Eng. Cat. Page	Price
RA-160-10	10		76	50	57-58	\$ 141.50
RA-160-12	12		76	60	57-58	141.50
RA-225-10	10	5 LGS.	92	50	57-58	164.35
RA-225-12	12	36 Nuts	92	60	57-58	164.35
RA-300-10	10	& Bolts	92	50	57-58	230.90
RA-300-12	12		144	60	57-58	230.90

Catalog Number	Wt. 100 Sets	Package 100 Sets	Eng. Cat. Page	Price 100 Sets
----------------	--------------	------------------	----------------	----------------



RA-BN-5/8

RA-BN-3/4

RA-BN-5/8 Use with RA-160 & RA-225	4	3/8"-16 X 3/4" lg	58	\$ 26.05
---	---	-------------------	----	----------

RA-BN-3/4 Use with RA-300	5	3/8"-16 X 3/4" lg	58	\$ 28.85
---------------------------------	---	-------------------	----	----------

Catalog Number	Wt. 100	Package	Eng. Cat. Page	Price 100
----------------	---------	---------	----------------	-----------



RA-GP	10	25	58	\$ 67.95
-------	----	----	----	----------



RA-C	17	1	58	\$ 356.20
------	----	---	----	-----------



RA-RC	2	2	58	\$ 29.45
RA-SC	2	2	58	40.65

RA-RC				RA-SC
-------	--	--	--	-------

Catalog Number	Size	Wt./ 100 Ft.	Ft./ Bundle	Eng. Cat. Page	Price Per 100 Ft.
----------------	------	--------------	-------------	----------------	-------------------

SPECIAL METALS

Aluminum-Channel*

A-1200-AL		71	500	55-56	\$ 565.70
A-1200-HS-AL		70	500	55-56	684.45
A-1202-AL		135	250	55-56	†
B-1200-AL		52	500	55-56	404.10
B-1202-AL		93	500	55-56	

Available in 10' and 20' lengths

Discount Schedule A

Catalog Number	Size	Wt./ 100 Pcs.	Pcs./ Carton	Eng. Cat. Page	Price Per 100 Pieces
----------------	------	---------------	--------------	----------------	----------------------

Aluminum

A-100	¼				†
Spring Nut	¾	3	100	55-56	†
	½	3.6	100	55-56	†
AB-100	¾	2.5	100	55-56	†
Spring Nut					

Discount Schedule B

Aluminum

702	½	4	100	55-56	\$ 147.15
Conduit	¾	5	100	55-56	154.80
Clamp with	1	7	100	55-56	177.25
Stainless	1¼	6	100	55-56	205.65
Hardware	1½	11	100	55-56	275.35
	2	12	25	55-56	411.50
	2½	14	25	55-56	289.30
	3	17	25	55-56	509.40
	3½	21	25	55-56	384.55
	4	23	10	55-56	451.45
	6	24	10	55-56	741.35
	8	25	10	55-56	969.55

Discount Schedule C

Catalog Number	Size	Wt./ 100 Ft.	Ft./ Bundle	Eng. Price Page	Per 100 Ft. Type 304	Type 316
----------------	------	--------------	-------------	-----------------	----------------------	----------

Stainless Steel-Channel*

A-1200-SS		190	500	55-56	†	
A-1200-HS-SS		185	500	55-56	†	
B-1400-SS		97	500	55-56	†	
B-1400-HS-SS		92	500	55-56	†	

Available in 10' and 20' lengths

Discount Schedule A

Catalog Number	Size	Wt./ 100 Pcs.	Pcs./ Carton	Eng. Cat. Page	Price Per 100 Pcs. or Ft*	Type 304	Type 316
----------------	------	---------------	--------------	----------------	---------------------------	----------	----------

Stainless Steel

A-100	¼	7	100	55-56	†		
Spring Nut	¾	10	100	55-56	†		
	½	12	10	55-56	†		
B-100	¼	7	100	55-56	†		
Spring Nut	¾	7	100	55-56	†		
	½	7	100	55-56	†		
AB-100	¼	9	100	55-56	†		
Nut	¾	9	100	55-56	†		
	½	6	100	55-56	†		
E-142	¾ X 1	4	50	55-56	†		
Bolt	¾ X 1¼	5	50	55-56	†		
	¾ X 1½	6	50	55-56	†		
	½ X 1	8	100	55-56	†		
AB-202	—	35	50	55-56	†		
AB-205	—	78	25	55-56	†		
Angle Bracket							
AB-241	¾	18	100	55-56	†		
Washer	½	17	100	55-56	†		
C-775-L	¾	38	50	55-56	†		
C-Clamp	½	41	50	55-56	†		
U-501	—	90	20	55-56	†		
U-502	—	100	20	55-56	†		
C-Clamp							
H-104	¾ X 12	29	300	55-56	†		
Threaded Rod	½ X 12	54	150	55-56	†		

Discount Schedule B

†Contact Factory

Catalog Number	Size	Wt./ 100 Pcs.	Pcs./ Carton	Eng. Price Page	Price Per 100 Pieces	
					Type 304	Type 316

SPECIAL METALS (continued)

Stainless Steel

701	¼	8	100	55-56	†
Conduit	¾	8	100	55-56	†
Clamp	½	13	100	55-56	†
702	½	11	100	55-56	†
Conduit	¾	15	100	55-56	†
Clamp	1	17	100	55-56	†
	1¼	18	50	55-56	†
	1½	29	50	55-56	†
	2	34	50	55-56	†
	2½	40	25	55-56	†
	3	47	25	55-56	†
	3½	62	25	55-56	†
	4	67	25	55-56	†
	5	80	25	55-56	†
	6	102	10	55-56	†
	8	130	10	55-56	†

Discount Schedule C

†Contact Factory

CHANNEL FINISH COMPARISON

FEATURE	Goldguard EC	Painted GR	Electro- Galvanized EG	Pre- Galvanized PG	Hot-Dip Galvanized HDG
Zinc Electro-Galvanized	YES	NO	YES	NO	NO
Zinc Dichromate Finish	YES	NO	NO	NO	NO
Galvanized After Fabrication	YES	NO	YES	NO	YES
Elimination of Raw Edges	YES	YES	YES	NO	YES
Smooth Dry Finish	YES	YES	YES	NO	NO
Superior Paint Base	YES	NO	NO	NO	NO

EC – GOLDGUARD

- The standard finish for all Superstrut products.
- First coat is electro-plated¹ zinc.
- Second coat is zinc dichromate (gold color).
- Applied after fabrication.
- No raw unfinished edges.
- Excellent corrosion resistance.
- Superior paint base.

¹ Electro-plating creates a cohesive molecular bond between the steel & zinc.

EG – ELECTRO-GALVANIZED

- A durable electro-galvanized finish.
- Applied after fabrication.
- Good durable finish for threaded items.
- Finish is silver color.

PG – PRE-GALVANIZED

- A durable hot-dipped finish.
- Applied at the steel mill.
- Affords no protection to raw edges after slitting, punching & cutting.
- Finished product usually not cleaned.
- Poor base coat for paint.

HDG – HOT-DIPPED GALVANIZED

- A durable hot-dipped finish.
- Applied after fabrication.
- Cannot be applied on many threaded items.
- Finish is uneven, dull silver color.
- Poor base coat for paint.
- Most "costly" form of galvanization.

GR – PAINTED

- Urethane powder coated green.
- Hard, durable finish
- 1.5 mil thickness.
- 1,000 hour corrosion resistance in accordance to ASTM 117 salt spray test.
- Applied after fabrication

NOTES

For customer service please call our
representatives/sales offices listed below.

Electrical Components Group

ALABAMA

Robert B. Paul Co., Inc.
Phone: 404/696-7100
Fax: 404/691-4926

Atlanta Region
Phone: 404/993-8009
Fax: 404/993-6291

ALASKA

Lafferty Electric
Phone: 907/561-1205
Fax: 907/561-2367

Pacific Northwest Region
Phone: 408/453-5464
Fax: 408/453-5497

ARIZONA

Electrical Development Group, Ltd.
Phone: 602/437-3347
Fax: 602/437-9763

Pacific Southwest Region
Phone: 714/754-7266
Fax: 714/754-7734

ARKANSAS

Rhodes Electrical Sales
Agency
Phone: 901/371-0093
Fax: 901/377-8628

Dallas Region
Phone: 214/980-1590
Fax: 214/980-1599

CALIFORNIA (Northern)

J. M. Electrical Sales
Phone: 510/887-8444
Fax: 510/887-6173

Pacific Northwest Region
Phone: 408/453-5464
Fax: 408/453-5497

CALIFORNIA (Southern)

Pacific Southwest Region
Phone: 714/754-7266
Fax: 714/754-7734

COLORADO

Electrical Lines, Inc.
Phone: 303/722-5721
Fax: 303/777-1451

Pacific Southwest Region
Phone: 714/754-7266
Fax: 714/754-7734

CONNECTICUT

A. A. MacPherson Co., Inc.
Phone: 617/828-9400
Fax: 617/821-1159

New York Region
Phone: 908/521-0700
Fax: 609/395-8519

DELAWARE

Joseph E. Biben Sales
Phone: 215/985-9400
Fax: 215/545-0990

Philadelphia Region
Phone: 215/491-0993
Fax: 215/491-9022

FLORIDA

Tampa Region
Phone: 813/968-6223
Fax: 813/968-8028

GEORGIA

Robert B. Paul Co., Inc.
Phone: 404/696-7100
Fax: 404/691-4926

Atlanta Region
Phone: 404/993-8009
Fax: 404/993-6291

HAWAII

Don Thomas & Associates
Phone: 808/262-4818
Fax: 808/262-8747

Pacific Southwest Region
Phone: 714/754-7266
Fax: 714/754-7734

IDAHO (Northern)

Pacific Western Agencies
Phone: 206/763-1802
Fax: 206/762-1834

IDAHO (Southern)

Pacific Northwest Region
Phone: 408/453-5464
Fax: 408/453-5497

Dave Robert Company
Phone: 801/269-1445
Fax: 801/269-1309

IDAHO (Pacific Northwest)

Phone: 408/453-5464
Fax: 408/453-5497

ILLINOIS

Evans, Lipka & Associates, Inc.
Phone: 319/373-2046
Fax: 319/373-1680

Ken Way Company
(Southern, IL)
Phone: 314/469-9998
Fax: 314/469-3925

Chicago Region
Phone: 708/894-2010
Fax: 708/894-7251

INDIANA

Lester Sales Company
Phone: 317/244-7811
Fax: 317/248-2369

Detroit Region
Phone: 313/477-7760
Fax: 313/477-3799

IOWA

Evans, Lipka & Associates, Inc.
Phone: 319/373-2046
Fax: 319/373-1680
(Marion Office)

Chicago Region
Phone: 708/894-2010
Fax: 708/894-7251

KANSAS

Cleaves-Bessmer-Marietti
Phone: 816/353-6011
Fax: 816/353-7277

Dallas Region
Phone: 214/980-1590
Fax: 214/980-1599

KENTUCKY

Lester Sales Company
Phone: 317/244-7811
Fax: 317/248-2369

Detroit Region
Phone: 313/477-7760
Fax: 313/477-3799

LOUISIANA

Houston Region
Phone: 713/367-6284
Fax: 713/367-6288

MAINE

A. A. MacPherson Co., Inc.
Phone: 617/828-9400
Fax: 617/821-1159

New York Region
Phone: 908/521-0700
Fax: 609/395-8519

MARYLAND

Market Line Ltd.
Phone: 410/760-7795 (MD)
Phone: 410/858-5251 (DC)
Fax: 410/760-7798

Philadelphia Region
Phone: 215/491-0993
Fax: 215/491-9022

MASSACHUSETTS

A. A. MacPherson Co., Inc.
Phone: 617/828-9400
Fax: 617/821-1159

New York Region
Phone: 908/521-0700
Fax: 609/395-8519

MICHIGAN

Farori & Associates
Phone: 313/534-3500
Fax: 313/534-4648

Chicago Region
Phone: 708/894-2010
Fax: 708/894-7251

MINNESOTA

Chicago Region
Phone: 708/894-2010
Fax: 708/894-7251

MISSISSIPPI (Northern)

Rhodes Electrical Sales Agency
Phone: 901/371-0093
Fax: 901/377-8628

Dallas Region
Phone: 214/980-1590
Fax: 214/980-1599

MISSISSIPPI (Southern)

Houston Region
Phone: 713/367-6284
Fax: 713/367-6288

MISSOURI (Western)

Cleaves-Bessmer-Marietti
Phone: 816/353-6011
Fax: 816/353-7277

Dallas Region
Phone: 214/980-1590
Fax: 214/980-1599

MISSOURI (Eastern)

Ken Way Company
Phone: 314/469-9998
Fax: 314/469-3925

Chicago Region
Phone: 708/894-2010
Fax: 708/894-7251

MONTANA

O.J. Electric Sales
Phone: 406/248-9224
Fax: 406/245-6943

PACIFIC NORTHWEST REGION

Phone: 408/453-5464
Fax: 408/453-5497

NEBRASKA

Evans, Lipka & Associates, Inc.
Phone: 402/421-8282
Fax: 402/421-8288

Electrical Lines, Inc.
Phone: 303/722-5721
Fax: 303/777-1451
(Scottsbluff Area Only)

Chicago Region
Phone: 708/894-2010
Fax: 708/894-7251

For customer service please call our
representatives/sales offices listed below.

Electrical Components Group

Pacific Southwest Region
Phone: 714/754-7266
Fax: 714/754-7734
(Sioux, Scotts Bluff,
Banner, Kimball Counties)

NEVADA
J. M. Electrical Sales
Phone: 510/887-8444
Fax: 510/887-6173

Pacific Northwest Region
Phone: 408/453-5464
Fax: 408/453-5497

Pacific Southwest Region
Phone: 714/754-7266
Fax: 714/754-7734
(Clark County)

NEW HAMPSHIRE
A. A. MacPherson Company, Inc.
Phone: 617/828-9400
Fax: 617/821-1159

New York Region
Phone: 908/521-0700
Fax: 609/395-8519

NEW JERSEY
Joseph E. Biben Sales
(Southern)
Phone: 215/985-9400
Fax: 215/545-0990

New York Region
Phone: 908/521-0700
Fax: 609/395-8519

NEW MEXICO
Electrical Lines, Inc.
Phone: 303/722-5721
Fax: 303/777-1451

Pacific Southwest Region
Phone: 714/754-7266
Fax: 714/754-7734

NEW YORK (Northern)
W. E. Daw Company, Inc.
Phone: 315/463-8541
Fax: 315/463-0368

New York Region
Phone: 908/521-0700
Fax: 609/395-8519

NEW YORK (Metro)
New York Region
Phone: 908/521-0700
Fax: 609/395-8519

NORTH CAROLINA
Paul Lumpkin Co., Inc.
Phone: 704/376-8428
Fax: 704/375-7268
Charlotte Region
Phone: 704/845-8080
Fax: 704/845-8056

NORTH DAKOTA
G. L. Brusacoram Sales
Phone: 612/872-8222
Fax: 612/872-1605

Chicago Region
Phone: 708/894-2010
Fax: 708/894-7251

OHIO
Pittsburgh Region
Phone: 412/323-5431
Fax: 412/323-5434

OKLAHOMA
George E. Anderson Company
Phone: 214/428-3731
Fax: 214/428-6111

Dallas Region
Phone: 214/980-1590
Fax: 214/980-1599

OREGON
Pacific Western Agencies
Phone: 503/227-5555
Fax: 503/227-0091
(Portland)

Pacific Northwest Region
Phone: 408/453-5464
Fax: 408/453-5497

PENNSYLVANIA (East)
Joseph E. Biben Sales
Phone: 215/985-9400
Fax: 215/545-0990

Philadelphia Region
Phone: 215/491-0993
Fax: 215/491-9022

PENNSYLVANIA (West)
Pittsburgh Region
Phone: 412/323-5431
Fax: 412/323-5434

RHODE ISLAND
A. A. MacPherson Company, Inc.
Phone: 617/828-9400
Fax: 617/821-1159

New York Region
Phone: 908/521-0700
Fax: 609/395-8519

SOUTH CAROLINA
Robert B. Paul Co., Inc.
Phone: 404/696-7100
Fax: 404/691-4926

Atlanta Region
Phone: 404/993-8009
Fax: 404/993-6291

SOUTH DAKOTA
G. L. Brusacoram Sales
Phone: 612/872-8222
Fax: 612/872-1605

Chicago Region
Phone: 708/894-2010
Fax: 708/894-7251

Pacific Southwest Region
Phone: 714/754-7266
Fax: 714/754-7734
(Harding, Perkins, Butte,
Lawrence, Meade,
Pennington, Custer, Fall
River, Shannon Counties)

TENNESSEE (East, Mid State)
Robert B. Paul Co., Inc.
Phone: 404/696-7100
Fax: 404/691-4926

Atlanta Region
Phone: 404/993-8009
Fax: 404/993-6291

TENNESSEE (Western)
Rhodes Electrical Sales
Agency
Phone: 901/371-0093
Fax: 901/377-8628

Dallas Region
Phone: 214/980-1590
Fax: 214/980-1599

TEXAS (Northern)
George E. Anderson Company
Phone: 214/428-3731
Fax: 214/428-6111

Dallas Region
Phone: 214/980-1590
Fax: 214/980-1599

TEXAS (Southern)
Houston Region
Phone: 713/367-6284
Fax: 713/367-6288

Pacific Southwest Region
Phone: 714/754-7266
Fax: 714/754-7734
(El Paso County)

UTAH
Dave Robert Company
Phone: 801/269-1445
Fax: 801/269-1309

Pacific Northwest Region
Phone: 408/453-5464
Fax: 408/453-5497

VERMONT
A. A. MacPherson Company, Inc.
Phone: 617/828-9400
Fax: 617/821-1159

New York Region
Phone: 908/521-0700
Fax: 609/395-8519

VIRGINIA
Paul Lumpkin Co., Inc.
Phone: 704/376-8428
Fax: 704/375-7268

Charlotte Region
Phone: 704/845-8080
Fax: 704/845-8056

WASHINGTON
Pacific Western Agencies
Phone: 206/763-1802
Fax: 206/762-1834

Pacific Northwest Region
Phone: 408/453-5464
Fax: 408/453-5497

WEST VIRGINIA
Pittsburgh Region
Phone: 412/323-5431
Fax: 412/323-5434

WISCONSIN (Eastern)
Chicago Region
Phone: 708/894-2010
Fax: 708/894-7251

WISCONSIN (Western)
G. L. Brusacoram Sales
Phone: 612/872-8222
Fax: 612/872-1605

WYOMING
Electrical Lines, Inc.
Phone: 303/722-5721
Fax: 303/777-1451

Pacific Southwest Region
Phone: 714/754-7266
Fax: 714/754-7734

CANADA
Thomas & Betts - Montreal
Phone: 514/489-7525
Fax: 514/489-6900

Thomas & Betts - Iberville
Phone: 514/347-5318
Fax: 514/347-1976

Blackburn - Canada
Phone: 514/636-9109
Fax: 514/636-0475

**For customer service please call our
representatives/sales offices listed below.**

Heating, Mechanical, Refrigeration Group

EASTERN REGION

Billingsley & Assoc., Inc.
Phone: (504) 733-7624
Fax: (504) 733-6904

Cummins-Wagner Co., Inc.
Phone: (410) 792-4230
Fax: (301) 490-7156

Gailey Energy Ltd.
Phone: (716) 254-2223
Fax: (716) 254-4554

H & K Sales Corp.
Phone: (812) 421-1894
Fax: (812) 421-1998

A.A. MacPherson
Phone: (617) 828-9400
Fax: (617) 821-1159

McAllister & Associates, Inc..
Phone: (407) 880-1117
Fax: (407) 880-3099

John T. McAuliffe Sales Co..
Phone: (313) 625-1161
Fax: (313) 625-6720

Smith & Stevenson
Phone: (704) 525-3388
Fax: (704) 527-0539

Spec Tec, Inc.
Phone: (407) 295-2202
Fax: (407) 299-2765

United Components
Phone: (201) 612-9119
Fax: (201) 612-8736

WESTERN REGION

S & G Sales Co.
Phone: (713) 224-4177
Fax: (713) 224-3261

Buche & Associates
Phone: (303) 934-4969
Fax: (303) 934-6131

Camelback Sales & Marketing
Phone: (602) 994-5188
Fax: (602) 994-9409

Crown Sales, Inc.
Phone: (808) 845-7881
Fax: (808) 841-4504

R.E. Fitzpatrick Sales
Phone: (801) 566-7156
Fax: (801) 566-4979

Larry Harrington Co., Inc.
Phone: (503) 228-4324
Fax: (503) 228-0219

Branches
Phone: (206) 455-0800
Fax: (206) 455-4640

Phone: (509) 325-1654
Fax: (509) 325-6838

Long Sales, Inc.
Phone: (310) 946-1000
Fax: (310) 946-4753

Mayco Sales
Phone: (214) 241-1776
Fax: (214) 241-1777

Minus Forty Sales
Phone: (214) 494-1808
Fax: (214) 494-2027

J.K. Neuhauser Sales Co.
Phone: (908) 771-7800
Fax: (708) 771-3157

Products, Inc.
Phone: (515) 288-5738
Fax: (515) 288-2574

RSJK Sales Company
Phone: (314) 842-2334
Fax: (314) 842-7201

Schu Marketing Associates
Phone: (612) 593-5616
Fax: (612) 593-5654

Thomas J. Rodeno & Assoc.
Phone: (303) 296-4600
(800) 824-3657
Fax: (303) 296-6724

William L. Terpening
Phone: (505) 899-1748
Fax: (505) 898-1431

W & R Industrial Products
Phone: (415) 493-7100
Fax: (415) 493-7107

Thomas & Betts

Thomas & Betts
Electrical Components Group
1555 Lynnfield Road
Memphis, Tennessee 38119
(901) 682-8221 ext. 8324 (Technical Services)

For customer service, please call our representatives,
sales offices listed in the inside back pages of this catalog.

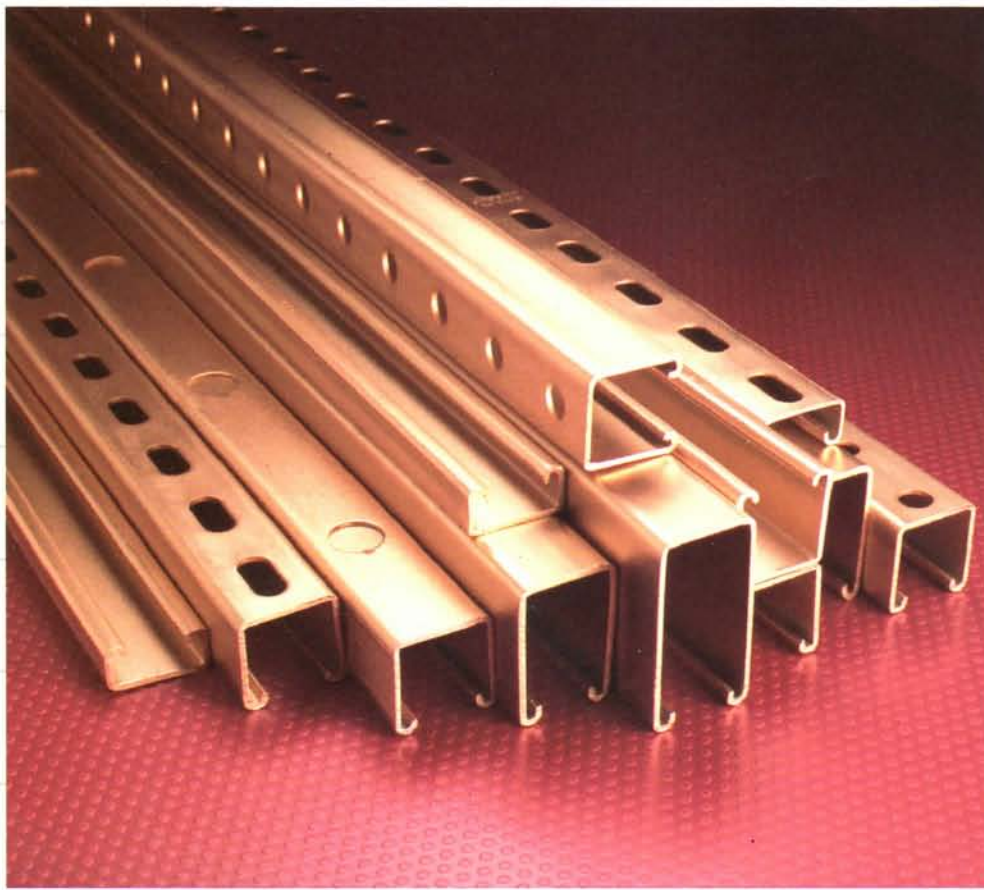

Thomas & Betts